

The
RCA RADIOTRON
MANUAL

TECHNICAL SERIES

No. R-10

Price 25 cents

RCA RADIOTRON CO., Inc.

HARRISON, NEW JERSEY

Division Sales Offices

EASTERN

NEW YORK, N. Y.
261 FIFTH AVENUE

CENTRAL

CHICAGO, ILL.
520 N. MICHIGAN AVE.

WESTERN

KANSAS CITY, MISSOURI
2300 FIDELITY BANK BUILDING

DISTRICT SALES OFFICES IN PRINCIPAL CITIES



The
RCA RADIOTRON
MANUAL

TECHNICAL SERIES

No. R-10

Price 25 cents

RCA RADIOTRON CO., Inc.

HARRISON, NEW JERSEY

Division Sales Offices

EASTERN

**NEW YORK, N. Y.
261 FIFTH AVENUE**

CENTRAL

**CHICAGO, ILL.
520 N. MICHIGAN AVE.**

WESTERN

**KANSAS CITY, MISSOURI
2300 FIDELITY BANK BUILDING**

DISTRICT SALES OFFICES IN PRINCIPAL CITIES

The
RCA RADIOTRON
MANUAL



TECHNICAL SERIES
No. R-10

Copyright, 1932
by
RCA RADIOTRON CO., Inc.

FOREWORD

The RCA RADIOTRON MANUAL has been prepared especially to supply technical information regarding the characteristics and operation of RCA Radiotrons to those who work or experiment with radio tubes and circuits.

Careful consideration has been given to the selection of material which presents general and specific tube information in the most useful and helpful form.

Tube types have been arranged in numerical sequence on the basis of the last two digits of model number designations. This is in accordance with our program of generally utilizing a two digit system for identifying tubes as evidenced by the new type numbers, i.e., 46, 56, 57, 58, and 82. Eventually, the two digit system will be extended to practically all of the older models by dropping the first digit of the present three digit designations.

This Manual will be found valuable by radio service men, radio technicians, experimenters, radio amateurs, and those who have an interest in the technical aspects of radio tubes.

Commercial Engineering Section
RCA RADIOTRON CO., INC.
Harrison, New Jersey

CONTENTS

	PAGE
ELECTRONS AND ELECTRODES	1
Cathodes, Diodes, Triodes, Tetrodes, Pentodes	
MANUFACTURE OF RCA RADIOTRONS	7
RADIO TUBE CHARACTERISTICS	10
Static Characteristics	
Dynamic Characteristics	
Amplification Factor, Plate Resistance, Mutual Conductance	
RADIO TUBE APPLICATION	12
Amplification	
Voltage, Power, Super-Control, Class B	
Detection	
Grid Leak Method, Grid Bias Method	
Oscillation	
INSTALLATION	18
Filament and Heater Circuits, Plate Voltage,	
Grid Voltage, Screen Voltage, Shielding,	
Output Coupling Devices	
SOCKET CONNECTIONS	39
CHARACTERISTICS CHART	40
MAXIMUM OVERALL DIMENSIONS	42

INDEX OF TUBE TYPES

TYPE	PAGE	TYPE	PAGE
WD-11 (On Chart)	40	RCA-233	44
WX-12 (On Chart)	40	RCA-234	46
RCA-46	62	RCA-235	48
RCA-56	69	RCA-236	51
RCA-57	71	RCA-237	53
RCA-58	73	RCA-238	55
RCA-82	81	RCA-239	57
UX-112-A	25	UX-240 (On Chart)	40
UX-120	27	UX-245	60
UX-171-A	76	RCA-247	66
UV-199	83	UX-250	68
UX-199	83	UX-280	78
UX-200-A (On Chart)	40	UX-281	80
UX-201-A	22	UX-841	Inside Back Cover
RCA-210	24	RCA-852	Inside Back Cover
UX-222	28	RCA-864	Inside Back Cover
UY-224-A	29	RCA-865	Inside Back Cover
UX-226	31	RCA-866	Inside Back Cover
UY-227	33	RCA-868	Inside Back Cover
RCA-230	35	UX-874 (On Chart)	41
RCA-231	37	UV-876 (On Chart)	41
RCA-232	38	UV-886 (On Chart)	41

The RCA Radiotron MANUAL

Electrons and Electrodes

The radio tube is a marvelous device. Although it appears to be a fragile affair constructed of metal and glass, in reality it is a rugged instrument that makes possible the performing of operations, amazing in conception, with a precision and a certainty that is astounding. It is an exceedingly sensitive and accurate instrument—the product of coordinated efforts of engineers and craftsmen. Its construction requires materials from every corner of the earth. Its use is world-wide. Its future possibilities, even in the light of present day accomplishments, are but dimly foreseen, for each development opens new fields of design and application.

The radio tube consists of a cathode and one or more additional electrodes—all enclosed in an evacuated glass bulb—with their electrical connections brought to exterior terminals. The cathode supplies electrons while the other electrodes control and collect them.

The importance of the radio tube lies in its ability to control almost instantly the flight of the millions of electrons supplied by the cathode. It accomplishes this with a minimum of control energy. Because it is almost instantaneous in its action, the radio tube can operate efficiently and accurately at electrical frequencies much higher than possible with rotating machines.

All matter exists in the solid, liquid, or gaseous state. These three forms of matter consist entirely of minute divisions known as molecules. Molecules are assumed to be composed of atoms. According to a present accepted theory, atoms have a nucleus which is a positive charge of electricity. Around this nucleus revolve tiny charges of negative electricity known as "electrons." Scientists have estimated that these invisible bits of electricity weigh only 1/46 billion, billion, billion, billionths of an ounce since they may travel at speeds of thousands of miles per second.

Electron movement may be accelerated by the addition of energy. Heat is one form of energy which can be conveniently used to speed up the electron. For example, if the temperature of a metal is gradually raised, the electrons gain velocity. When the metal becomes hot enough to glow, some electrons may acquire sufficient speed to break away from their nuclei. This action is utilized in the radio tube to produce the necessary electron supply.

CATHODES

A cathode is an essential part of a radio tube since it supplies the electrons necessary for tube operation. In general, heat is the form of energy applied to the cathode to release the electrons. The method of heating the active material of the cathode may be used to distinguish between the different forms of cathodes. For example, a directly-heated cathode, or **filament-cathode**, is a wire heated by the passage of an electric current. An indirectly-heated cathode, or **heater-cathode**, consists of a filament, or heater, enclosed in a metal sleeve. The sleeve carries the active material on its outside surface and is heated by radiation and conduction from the heater.

A filament, or **directly-heated cathode**, may be further classified by identifying the filament or electron emitting material. The materials in regular use are, tungsten, thoriated-tungsten, and metals which have been coated with alkaline earth oxides. Tungsten filaments are made from pure metal. Since they must operate at high temperatures (a dazzling white) to emit sufficient electrons, a relatively large amount of filament power is required. Thoriated-tungsten filaments are drawn from tungsten slugs which have been impregnated with thoria. Due to

THE RCA RADIOTRON MANUAL

the thorium, these filaments liberate electrons at a more moderate temperature (a bright yellow) and are, therefore, much more economical of filament power than are pure tungsten filaments. Alkaline earths are usually applied by coating a nickel alloy wire or ribbon with a mixture containing the materials. This coating, which is dried into a substantial layer on the filament, requires only a very low temperature (a dull red) to produce a copious supply of electrons. Coated filaments operate very efficiently and require relatively little filament power. However, each of these cathode materials has special advantages which determine the choice for a particular application. In general, tubes made with filament-cathodes or heater-cathodes and designed for use in radio receivers, utilize the coated construction.

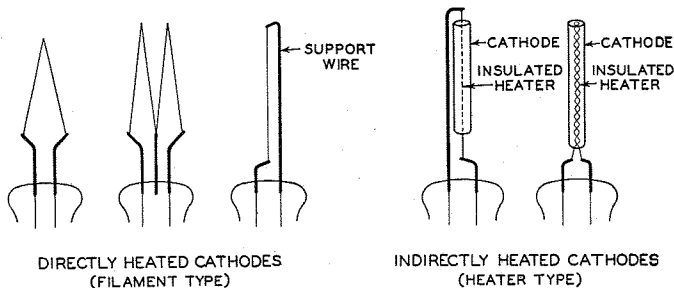

Filament-cathode types of tubes are particularly well suited for operation from a steady source of filament supply voltage such as a battery. Tubes for this service can be designed with cathodes which give economical production of electrons and, consequently, economical set operation. Tubes constructed primarily for economical battery operation are not very satisfactory for use with alternating current filament supply, due to the variation in electron emission and potential in the space charge region which occurs with each alternation of the current. This variation is amplified by the tube and produces hum in the loudspeaker. When filament-cathode types of tubes are to be used on a-c filament supply, special precautions are taken in the design to reduce hum disturbances to a point where the hum will not be troublesome. These precautions include such features as the utilization of massive filaments which minimize temperature fluctuations, the use of filaments which have sufficient excess electron emission so that a very large temperature change is required to reduce the emission below the value needed for normal tube operation, and the proportioning of tube parts to minimize the electrostatic and magnetic effects produced by a.c. on the filament. The '26 is an example of a filament-cathode type of tube particularly useful for operation on a.c.

Heater-, or **indirectly-heated cathodes**, comprise an assembly of a thin metal sleeve coated with active material and a heater contained within and separated from the sleeve. The heater is made of tungsten wire and is used only for the purpose of heating the sleeve and its coating to an electron-emitting temperature. The tungsten wire is operated at a moderate temperature and supplies the energy for heating the sleeve.

The heater-cathode construction is well adapted for use in radio tubes intended for operation from a-c power lines. The use of separate parts for emitter and heater functions, the electrical insulation of the heater from the emitter, and the shielding effect of the sleeve may all be utilized in the design of the tube to prevent the a-c heater supply from causing hum. Representative types are the '24-A, '27, and '35. From the viewpoint of circuit design, the heater-cathode construction offers advantages in connection flexibility due to the electrical separation of the heater from the sleeve and active cathode surface. This feature, in conjunction with the freedom from electrical disturbances which might be introduced through the filament supply lines, has led also to the use of this construction in a series of tubes ('36-'39) designed particularly for automobile or d-c line radio sets.

THE RCA RADIOTRON MANUAL

DIODES

Electrons are of no value in a radio tube unless they can be put to work. A radio tube is designed with the necessary parts to utilize the electron flow. These parts consist of a cathode and one or more supplementary electrodes. The simplest form of radio tube contains two electrodes, a "cathode" and a "plate" and is often called a "diode," the family name for two-electrode tubes.

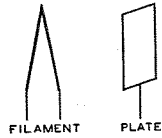

The electrodes are enclosed in a bulb with the necessary connections brought out through air-tight seals. The air is removed from the bulb to allow free movement for the electrons and to prevent injury to the emitting surfaces. When the cathode is heated, electrons leave the cathode surface and form an invisible cloud in the space around it. Any positive electric potential within the evacuated bulb will offer a strong attraction to the electrons (unlike electric charges attract; like charges repel). In a diode, the positive potential is applied to the second electrode, known as the anode. The potential is supplied by a suitable electrical source connected between the plate terminal and a cathode terminal. Under the influence of the positive plate potential, electrons flow from the cathode to the plate and return through the external plate battery circuit to the cathode, thus completing the circuit. This flow of electrons is known as the plate current and may be measured by a sensitive current meter.

If a negative potential is supplied to the plate, the free electrons in the space surrounding the cathode will be forced back to the cathode, and no plate current will flow. Thus, the tube permits electrons to flow from the cathode to the plate but not from the plate to the cathode. If an alternating voltage is applied to the plate, the plate is alternately made positive and negative. Plate current flows only during the time when the plate is positive. This phenomenon makes the tube useful as a rectifier of alternating current, that is, to provide a current flow always in the same direction. Rectifying action is utilized in a-c receivers to convert a.c. to d.c. for supplying "B," "C" and screen voltages to the other tubes in the receiver circuit. Rectifier tubes may have one plate and one cathode. The '81 is of this form and is called a **half-wave rectifier**, since current can flow only during one-half of the alternating-current cycle. When two plates and one or more cathodes are used in the same tube, current may be obtained on both halves of the a-c cycle. The '80 is an example of this type and is called a **full-wave rectifier**.

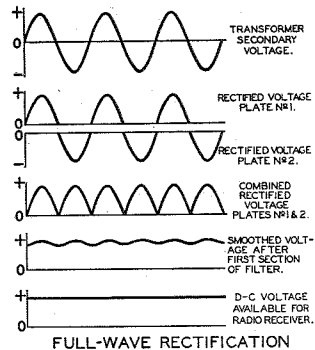

Not all of the electrons emitted by the cathode reach the plate. Some return to the cathode while others remain in the space between the cathode and plate for a brief period to form an effect known as **space-charge**. This charge has a repelling action on other electrons which leave the cathode surface, and impedes their passage to the plate. The extent of this action and the amount of space-charge is greatly dependent upon the cathode temperature and the plate potential. The higher the plate potential, the less is the tendency for the space electrons remaining to repel others. This effect may be noted by applying increasingly higher plate voltages to a tube operating at a fixed cathode voltage. Under these conditions, the maximum number of available electrons is fixed, but increasingly higher plate voltages will succeed in attracting a greater proportion of the free electrons.

Beyond a certain plate voltage, however, additional plate voltage has little effect in increasing the plate current because all of the electrons emitted by the cathode are being drawn to the plate. This maximum current is called **saturation current**,

THE RCA RADIOTRON MANUAL

and because it is an indication of the total number of electrons emitted, it is also known as the **emission current**, or, simply, **emission**. In most types of tubes, it is impossible to obtain this value by measurement, since the current flow is sufficiently large to change the emitting conditions, or, to damage the tube. As a result, emission values in practice are determined at some lower voltage which will not harm the tube. Different results will be obtained if a different cathode voltage or temperature is chosen, since the cathode temperature determines the number of available electrons.

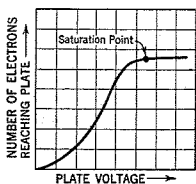

If space-charge effects were not present, it follows that the same electron flow could be produced at a lower plate voltage. One method of reducing the space-charge effect is utilized in several types of rectifier tubes, represented by the mercury-vapor rectifier 82. This tube contains a small amount of mercury which is partially vaporized when the tube is operated. The mercury vapor consists of tiny mercury atoms permeating the space inside the bulb. These atoms are bombarded by the electrons on their way to the plate. If the electrons are moving at a sufficiently high speed, the collisions will tear off electrons from the mercury atoms. When this happens, the mercury atom is said to be "ionized," that is, it has lost one or more electrons and, therefore, is charged positive. When ionization due to bombardment of mercury atoms by electrons leaving the filament occurs, the space-charge is neutralized by the positive mercury ions so that increased numbers of electrons are made available. A mercury-vapor rectifier has a small voltage drop between cathode and plate (about 15 volts). This drop is practically independent of current requirements up to the limit of emission of electrons from the filament but is dependent to some degree on bulb temperature.

TRIODES

When a third electrode, called the grid, is placed next to the cathode, the tube is known as a "triode." This is the family name for three-electrode types. The grid usually consists of a wire mesh or grating, the appearance of which suggests its name. Its construction allows practically unobstructed flight of the electrons from the cathode to the plate.

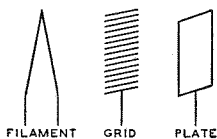

When the grid of a tube is made positive or negative with respect to the cathode, the plate current correspondingly increases or decreases. The grid is located much nearer the cathode than the plate so that a small voltage change on the grid will have the same effect on the plate current as a larger voltage change on the plate. A grid requires very little power, serving merely as a valve to control the plate current.

A negatively charged grid tends to force the space electrons back toward the filament. This action decreases the plate current. Plate current, in fact, may be reduced to zero (cut-off) by making the negative grid charge sufficiently large. On the other hand, when a positive charge is applied to the grid, the electrons are accelerated and increased plate current results.

It should be noted that this control action of the grid permits the use of the tube as an amplifier. A small grid voltage change produces a much larger plate current than would the same change in plate voltage. Typical three-electrode tubes are the '20, '27, 56, and '45.

The **control grid circuit (input circuit)** includes any device or devices connected between the control grid and cathode of a tube for the purpose of impressing an input or signal voltage on the control grid. It may consist of an antenna coupling coil, a transformer secondary, or any unit having one or all the factors of inductance, resistance and capacity. Since it is usually desirable to maintain the grid at some negative voltage (called grid bias) with respect to the cathode, the grid circuit will, in such cases, also include a source of voltage supply for that purpose. The grid bias supply (C-supply) may be a battery or other source of d-c voltage.

THE RCA RADIOTRON MANUAL

The **output circuit** is considered to include the parts of the circuit connected between the plate and cathode.

The electrodes of a radio tube form an electrostatic system, each electrode acting as one plate of a small condenser. For a three-electrode tube the capacitances are known as **interelectrode capacitances** and are those existing between the grid and plate, the plate and cathode, and the grid and cathode. Of these, the capacity between the grid and plate is generally of most importance. In high-gain radio-frequency amplifier circuits, this capacity may act to produce undesired coupling between the input and output circuits and, thereby, cause uncontrolled regeneration.

TETRODES

The effect of grid-plate capacitance in causing excess regeneration may be minimized or eliminated in a number of ways. One scheme requires the use of complicated circuit arrangements which set up counteracting effects to counterbalance the action of the grid-plate coupling. The second and preferable method is to eliminate as much as possible the grid-to-plate capacitance in the tube itself. This is accomplished by employing a fourth electrode in the tube which is known as the screen. The screen is placed between the plate and the grid and thus makes

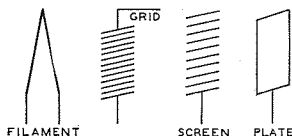

a four-electrode tube, or "tetrode." With this type of tube intricate circuits and balancing difficulties may be eliminated. Since the screen voltage largely determines the electron flow, small changes of plate voltage have little effect on plate current. This is desirable from the viewpoint of stability. The screen is constructed so that the flow of electrons is not materially obstructed, yet it serves to establish an electrostatic shield between the plate and grid. The screen is operated at some positive voltage lower than that of the plate and is by-passed to the cathode through a condenser. This by-pass condenser effectively grounds the screen for high-frequency currents and assists in reducing grid-plate capacitance to a minimum value. In general practice the grid-plate capacitance is reduced from an average of 8.0 micromicrofarads ($\mu\mu\text{f.}$) for a triode to 0.01 $\mu\mu\text{f.}$ or less for a screen grid tube. The reduction permits the attainment of stable amplification from screen grid tubes many times as high as that possible from three electrode tubes. Tubes of this type are represented by the '24-A, '32 and '35.

PENTODES

In all radio tubes, electrons striking the plate may, if moving at sufficient speed, dislodge other electrons. In two and three electrode types, these vagrant electrons usually cause no trouble because no positive electrode other than the plate itself is present to attract them so that they are eventually drawn back to the plate. Emission from the plate caused by bombardment of the plate by electrons from the cathode is called **secondary emission**, because the effect is secondary to the original cathode electrons. In the case of screen grid tubes, the proximity of the positive screen to the plate offers a strong attraction to these secondary electrons and particularly so if the plate voltage swings lower than the screen voltage. This effect lowers the plate current and limits the permissible plate swing for tetrodes.

The plate current limitation is removed when a fifth electrode, known as the suppressor, is placed in the tube between the screen and plate. The family name for five-electrode types is "pentode." The suppressor is usually connected to the

 THE RCA RADIOTRON MANUAL

cathode. Because of its negative potential with respect to the plate, it retards the flight of secondary electrons and diverts them back to the plate, where they can cause no trouble.

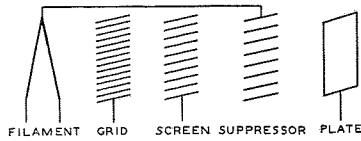

The suppressor is utilized at the present time in pentodes designed for two different functions. In power output pentodes, the suppressor makes possible a large power output with high gain, due to the fact that the plate swing can be made very large. Tubes of this type are represented by the '33, '38 and '47. In radio-frequency amplifier pentodes, the suppressor permits of obtaining a high voltage amplification at moderate values of plate voltage. In fact, the plate voltage may be as low as or lower than the screen voltage without serious loss in the gain capabilities of this type. Representative of this type are the '34 and '39. Further advantages in adaptability of tube design and application may be obtained by providing the suppressor with its own base terminal. With this arrangement, it is possible to obtain special control features by variation of the voltage applied to the suppressor. Typical tubes of this type are the 57 and 58.

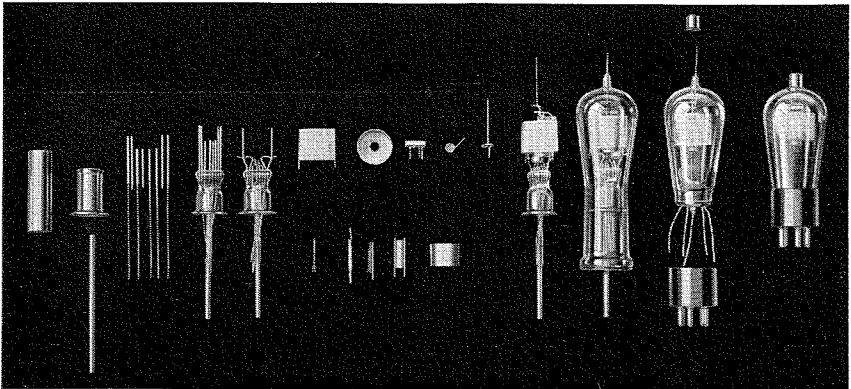

Parts Assembly of the '24-A

Manufacture of RCA Radiotrons

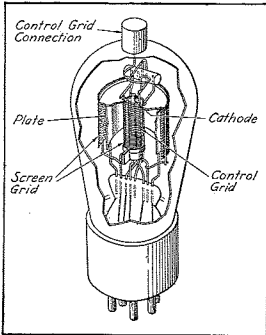

Interior View of '24-A

The age in which we live is vitally influenced by the thermionic vacuum tube. Without this device, the rapid strides which have been made in radio development would not have been possible. In a few short years, the radio tube has entered into our homes, offices, factories, and laboratories as an integral and essential part of modern living.

To meet the demands and exacting needs of this vast field, unceasing development of tubes and continuous improvement of tube manufacturing equipment has been required. Automatic tube making machinery has been developed to the stage where it now enters into practically every phase of our manufacturing activities. Such equipment is particularly well adapted for producing large quantities of tubes uniform in characteristics.

In attaining this uniformity, each component part of the tube structure must be precise in dimensions and free from impurities. Many of the parts are gauged to thousandths of an inch. Some parts require very much greater accuracy. The constituent materials of these parts are used only after they have passed exacting chemical tests. The need for this care may be appreciated when it is known that the active coating on some filaments weighs as little as 21 ten-millionths of a pound.

The same care which is used in the selection of individual parts is representative of the general manufacturing procedure for each of our types. Of these types, the '24-A is an excellent example for explaining the details of tube manufacture.

The initial step in the process consists in the making of the flare. The flare is the interior glass section through which passes the connecting wires from the bulb interior to the base pins of the completed radio tube. Standard lengths of glass tubing are fed into a machine which grips each one and moves it through a series of gas flames of increasing intensity. When the lower end assumes a bright yellow color (at this temperature the glass is about as

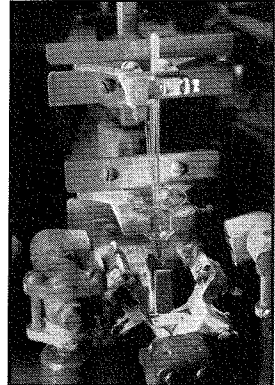

Sealing the Stem

soft as warm wax) a whirling cone rises to gently shape the molten edge of the tubing into a flange or flare. After the operation has been completed, the machine transports the flanged tubing through additional gas flames which play upon it at a point to give the correct length for the finished flare. A rotating glass cutter swings down into place under the tubing, then rises within it to cut off the section at the heated portion.

After inspection, the flare is sent to the stem machine. The flare is placed in the stem machine where the wire supports and connections are inserted. Correct spacing between wires is insured by a metal form which holds them in the proper position to be sealed into the glass.* Each wire

*It is interesting to know that before any metal enters into the construction of a tube, it must be thoroughly cleaned. This is accomplished by heating the metal at a high temperature in an atmosphere of hydrogen. The process cleans the most tarnished metal.

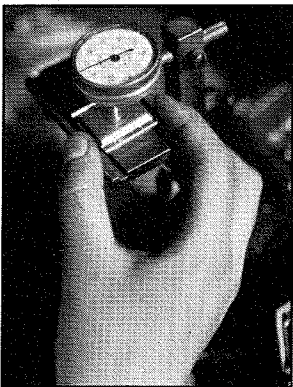

Gauging Plates

THE RCA RADIOTRON MANUAL

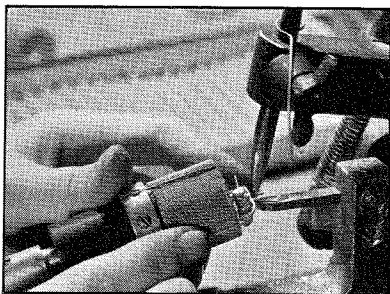

Welding Mount Assembly

in an air-tight seal, or press. The assembly then moves into position under an air jet which supplies compressed air to the exhaust tubing in order to blow a hole through the hot soft glass below the pinch. It is through this opening that the bulb is evacuated in a later operation. The entire part, known as the stem, is removed from the machine and annealed to prevent glass strains. After inspection, the annealed stem is sent to the stem-forming machine, where the wires are bent to the proper shape to take the parts to be mounted thereon.

After a careful inspection has been made, the stem is ready for the fitting of the additional parts, such as the plate, cathode, grid and screen. These parts are formed with accuracy by automatic machinery which operates more rapidly than the eye can follow. As these parts are mounted, they are electrically welded to insure permanent construction. First, the plate is mounted and welded to its respective supports. The grid and screen are next fastened in their positions. The outer section of the screen consists of a nickel mesh cylinder, while the inner section is a helical coil of fine wire. The sections are connected and held together at the top by a metal disc. The cathode is then inserted and welded to the proper terminals. The cathode consists of a heater wire enclosed in a metal sleeve from

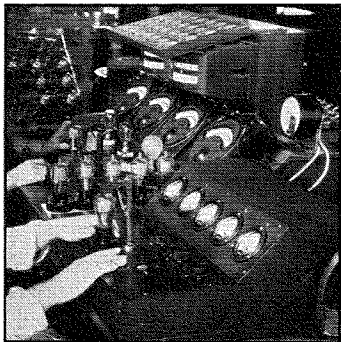

Electrical Inspection Tests

which it is electrically insulated. Great care is exerted in applying the active material to maintain exactness of coated area and thickness. After the sleeves have been sprayed, they are baked and carefully inspected.

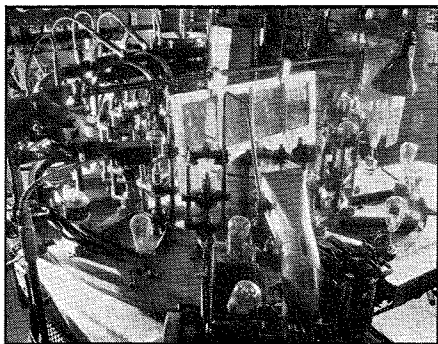

Bulb Sealing and Exhausting

Following the grid-assembly operation, the connecting wire which later is passed through the top of the glass bulb to the familiar metal cap, is welded to the control grid support. The "getter" cup, which contains pellets of magnesium, is then fastened to the grid support.

The unit, composed of a stem and attached parts, is known as the mount. It is inspected, tested for short circuits and transferred to the sealing-in and exhaust machine. Here it is placed on a rotating support, known as the sealing head, and a glass bulb is lowered over

THE RCA RADIOTRON MANUAL

it. Heat is applied both to the junction of the flare and bulb. The sealing head, constantly rotating, moves the tube into increasingly hotter zones where the glass is softened by the fires. The glass around the control grid lead is sealed immediately after the flare and bulb junction is made. The entire glass bulb is annealed in the process, after which the tube is transferred to the exhaust section of the machine where it is connected to the exhaust pumps.



Proving Life and Quality

The atmosphere is drawn from the bulb in successive operations. To insure a more complete exhaust, the principal metal parts of the tube are heated by powerful high-frequency currents induced by an external coil that automatically drops around the bulb. The intense heat, created in the metal by induction, frees the glass and metallic tube parts of occluded gases which are immediately removed from the bulb by the exhaust pumps. The getter is flashed or vaporized after the exhaust is nearly completed. The flashing is accomplished by means of induction from a movable high-frequency coil which is dropped down around the outside of the glass bulb. The current induced in the getter cup is great enough to provide the necessary heat to vaporize the getter. The vapor absorbs residual detrimental gases to make a better exhaust, and condenses in a silvery film on the inside of the glass bulb. This condensation acts as a vacuum keeper during the useful life of the tube. When the exhaust process has been completed, the tube is automatically sealed off, disconnected from the vacuum pump and transferred by belt to the basing machine.

Here the connection wires of the tube are properly threaded into the five pins of the base. The tube and base are passed through an oven, which hardens the cement on the inside edge of the base, thus fastening the bulb firmly to the base. Following the basing operation, projecting ends of the wires are cut off flush with the ends of the pins and soldered. A small metal cap is secured to the top of the bulb by means of cement and soldered to the grid lead.

The tube is once more examined for short and open circuits and then placed on a "seasoning rack" where voltages are applied to the electrodes. The tube is allowed to "season" for a length of time sufficient for its characteristics to become stabilized.

After the tube is seasoned, it is again tested for short and open circuits as well as for plate current, cathode activity (emission), a-c output, gas and leakage. On some types of tubes additional tests are made. Extremely accurate instruments are used for these tests. The completed and inspected product is finally wrapped in a corrugated holder and packed in its distinctive carton, ready for delivery to the purchaser.

From beginning to end, this brief story of one type of tube is indicative of the manufacturing skill, pains-taking care and precision processes employed in making each different tube described in this MANUAL.

Radio Tube Characteristics

The term "CHARACTERISTICS" is used to identify the distinguishing electrical features and values of a radio tube. These values may be shown in curve form or they may be tabulated. When given in curve form, they are called characteristic curves and may be used for the determination of tube performance and the calculation of additional tube factors.

Tube characteristics are obtained from electrical measurements of a tube in various circuits under certain definite conditions of voltages. Characteristics may be further described by denoting the conditions of measurements. For example, **Static Characteristics** are the values obtained with different d-c potentials applied to the tube electrodes, while **Dynamic Characteristics** are the values obtained with an a-c voltage applied to the control grid under various conditions of d-c potentials on the electrodes. The dynamic characteristics, therefore, are indicative of the performance capabilities of a tube under actual working conditions.

Plate characteristic curves and **mutual characteristic curves** both give information on static characteristics. These curves present the same information, but in two different forms to increase its usefulness. The plate characteristic curve is obtained by varying plate voltage and measuring plate current for different control grid bias voltages, while the mutual characteristic curve is obtained by varying control grid bias voltage and measuring plate current for different plate voltages. A plate characteristic family of curves is illustrated by Fig. 2. Fig. 1 gives the mutual characteristic family of curves for the same tube.

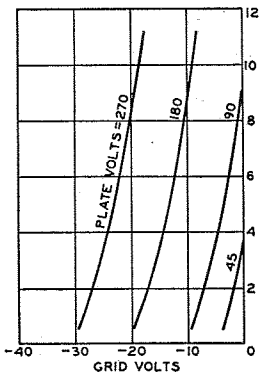

Fig. 1

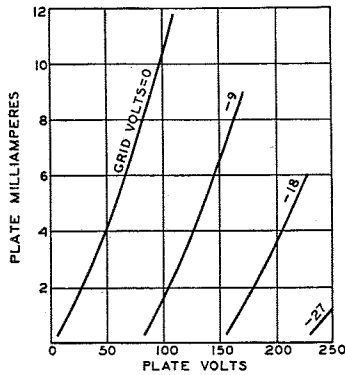

Fig. 2

Dynamic characteristics include amplification factor, plate resistance, and mutual conductance, and may be shown in curve form for variations in tube operating conditions.

The **amplification factor**, or μ , is the ratio between a small plate voltage change and the grid voltage change which produces an equal plate current variation. In other words, a voltage variation in the grid circuit has the same effect on plate current change as a plate voltage change equal to the grid voltage times the amplification factor. For example, if the grid voltage change is 5 volts for a change in plate current of one milliampere, and if a plate voltage change of 30 volts is also required to produce a change in plate current of one milliampere, the amplification factor is 30 divided by 5, i.e., 6.

The amplification factor (μ), is useful for calculating stage gain, as illustrated on page 12.

The **plate resistance** of a radio tube is the resistance of the path between cathode and plate to the flow of alternating current. It is the ratio of a small change in plate voltage to the corresponding change in plate current and is expressed in ohms, the unit of resistance. Thus, if a change of 0.001 ampere is produced by a plate voltage variation of 20 volts, the plate resistance (rp) is 20 divided by 0.001, i.e., 20000 ohms.

THE RCA RADIOTRON MANUAL

The **mutual conductance**, or grid-plate transconductance, is a factor which combines in one term the amplification factor and the plate resistance, and is the ratio of the first to the second. Thus, if the amplification factor is 10 and the plate resistance is 10000 ohms, the mutual conductance (gm) is 10 divided by 10000 equals 0.001 mho. A mho is the unit of conductance, the reciprocal of resistance, and was named by spelling ohm backwards. For convenience, a millionth of a mho, or a micromho, is used to express mutual conductance. So, in the example, 0.001 mho times a million, equals 1000 micromhos.

Mutual conductance (gm) is strictly defined as the quotient of a small change in plate current caused by a small change in grid voltage. This term is a very useful one for comparing tube performance capabilities, especially when tubes of similar characteristics are compared, but it has limited application for the comparison of tubes intended for different functions. For example, the 112-A has a mutual conductance of 1700 micromhos at 180 volts on the plate and -13.5 volts on the grid, while the '71-A has a mutual conductance of 1620 micromhos at 180 volts on the plate and -40.5 volts on the grid. As a power amplifier, however, the '71-A is capable of furnishing three times as much undistorted power to a loud-speaker as the 112-A. On the other hand, the 112-A is an excellent detector and voltage amplifier, services for which the '71-A is unsuitable.

TYPICAL TUNED RADIO-FREQUENCY CIRCUIT
2-VOLT FILAMENT TYPES

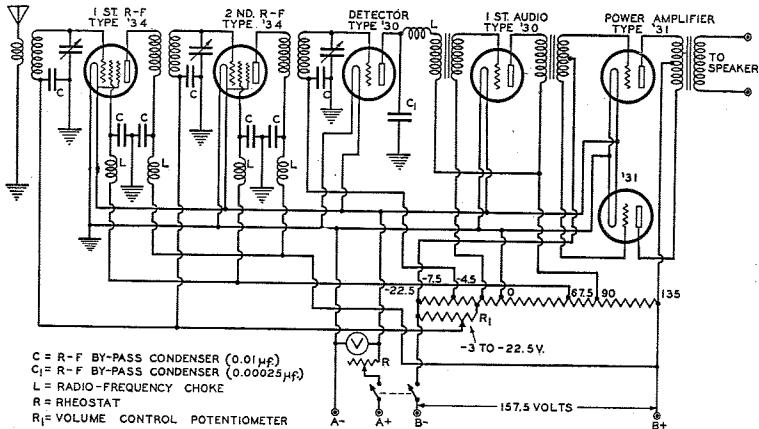

Resistance Strip—The values of the respective resistors in this strip should be chosen to give the indicated voltages at the various taps, as measured with a high resistance voltmeter. The total resistance in the strip should have a value such that the bleeder current will be approximately 8 milliamperes.

OPTIONAL DETECTOR AND AMPLIFIER—2-VOLT FILAMENT TYPES

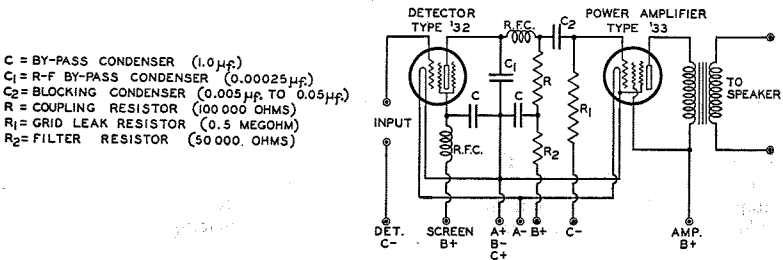

Radio Tube Applications

The applications of a radio tube are numerous, but they can be grouped broadly into three classes, according to operation. These are: Amplification; detection, which is a special form of rectification; and oscillation. Although these operations may take place at radio- or audio-frequencies and may involve the use of different circuits and different supplemental parts, the general considerations of these applications are basic and hold for all conditions.

AMPLIFICATION

As a **voltage amplifier**, a radio tube is used to reproduce voltage variations in the plate circuit. These variations are essentially of the same form as the input signal voltage impressed on the grid, but of increased amplitude. This is accomplished by operating the tube at a suitable grid bias so that the applied grid input voltage produces plate current variations proportional to the signal swings. The use of tubes in this manner is broadly identified as Class A service. Since the power controlled in the plate circuit is much larger than that required to swing the grid potential, amplification of the signal is obtained. Fig. 3 gives a graphical illustration of this method of amplification and shows, by means of the grid voltage vs. plate current characteristic, the effect of an input signal (S) applied to the grid of a tube. (O) is the resulting amplified plate current variation.

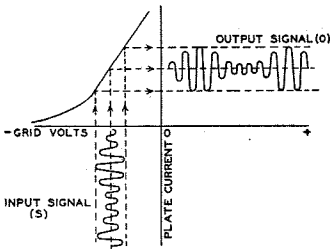

Fig. 3

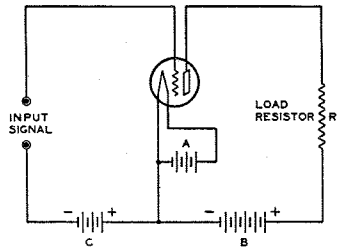

Fig. 4

The plate current flowing through the plate load resistor (R) of Fig. 4 causes a voltage drop which varies directly with the plate current. The ratio of this voltage variation produced in the load resistor to the grid input voltage is a measure of the voltage amplification, or gain, of the tube stage. This ratio is not the same as the amplification factor of the tube, but is determined by the combined effects of plate resistance, load resistance or impedance, and the amplification factor. The voltage amplification per stage due to the tube is expressed by the following convenient formulae:

$$\text{Voltage Amplification} = \frac{(\text{Amplification factor}) \times (\text{Plate load resistance})}{(\text{Plate load resistance}) + (\text{Plate resistance})} =$$

$$\frac{(\text{Mutual conductance in micromhos}) \times (\text{Plate resistance}) \times (\text{Plate load resistance})}{1000000 \times (\text{Plate resistance} + \text{Plate load})}$$

Load resistance and plate resistance values should be expressed in the same units, either ohms or megohms.

These formulae apply equally well to all types of amplifier tubes. If the load resistance is made increasingly large, the voltage amplification per stage approaches the amplification factor of the tube as a limiting value. Fig. 5 shows that gain increases with larger loads. Since the load resistor lowers the available plate voltage due to plate current flowing through it, the plate voltage swing obtainable is likewise reduced. This drop may be avoided by replacing the resistor with an

THE RCA RADIOTRON MANUAL

inductance. An inductance can be designed to have a high impedance to the signal and also to have a low resistance to direct current. The inductance, depending upon circuit requirements, may be an air-core coil, an iron-core choke, or a transformer primary.

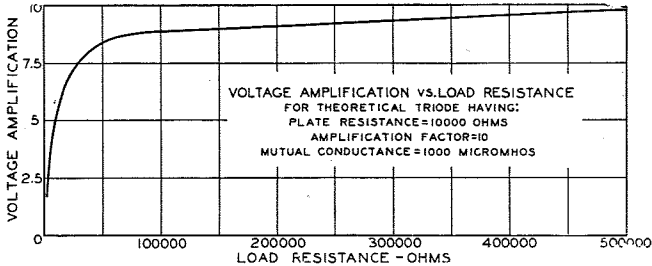

Fig. 5

The method of applying the input signal to the grid is important. It is possible to use an input circuit of high impedance, since the grid input impedance of radio tubes is very high as long as the grid bias is negative. If an input transformer is used the secondary impedance is made as high as other design conditions permit. In resistance-coupled circuits, the grid resistors usually range in value from $\frac{1}{2}$ to 2 megohms, depending upon the type of tube and the circuit. Too high a resistance may result in instability, while too low a value of grid resistance may result in low gain. The most suitable value will usually be determined by experiment.

As a **power amplifier**, a radio tube is used in the output stage of radio receivers to supply relatively large amounts of power to the loud speaker. For this application, large power output is of much greater importance than high voltage amplification, so that gain possibilities are sacrificed in the design of power tubes to obtain power handling capability. Power tubes of the triode type are characterized by comparatively high plate current, large grid bias, and low plate resistance. Power tubes of the pentode type give large power output with good sensitivity.

Either *push-pull* or *parallel* operation of power tubes may be employed to obtain increased output. The parallel connection (see Fig. 6) provides twice the output of a single tube without an increase in grid signal voltage; while the push-pull connection (see Fig. 7) will give twice the output at the same grid bias, but requires twice the input signal. Output slightly greater than twice the single tube value can be obtained from the push-pull connection by increasing the bias. This is permissible since the push-pull connection balances out 2nd harmonic distortion,—the usual limiting factor. In the latter case, the output is limited almost entirely by 3rd harmonic distortion.

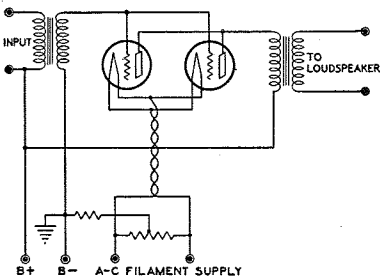

Fig. 6

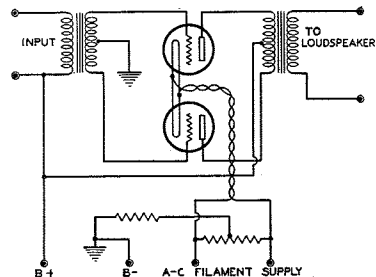

Fig. 7

THE RCA RADIOTRON MANUAL

The operation of power tubes so that the grids run positive is inadvisable except under conditions, such as are discussed later in this section for Class B amplifiers.

Power amplifier output for triodes can be calculated without serious error from the plate family of curves by assuming a pure resistance load. The proper plate current, grid bias, and optimum load resistance, as well as the per cent 2nd harmonic distortion, can also be determined. The calculations are made graphically and are illustrated by Fig. 8 for given conditions. The procedure is as follows: A straight line XY is drawn on the plate family of curves intersecting the plate voltage at a trial value of plate current at a point (P) and having a slope corresponding to the load resistance chosen. The slope of XY is determined by adjusting the line so that the plate voltage intersection at zero plate current divided by the plate current intersection at zero plate voltage is equal to the trial load resistance value; or, as is sometimes more convenient, by drawing line XY through point (P) parallel to some other line AB which has the proper slope.

In calculating power output, it is assumed that the peak alternating grid voltage is just sufficient to swing the grid from the operating bias value to zero bias on the positive swing and to a value twice the fixed bias on the negative swing. Identifying the maximum and minimum values of plate voltage and plate current for the grid voltage swing as E max., E min., I max., I min., the power output is given by the formula:

$$\text{Power Output} = \frac{(I \text{ max.} - I \text{ min.}) \times (E \text{ max.} - E \text{ min.})}{8}$$

If E is in volts and I in milliamperes, power output is in milliwatts.

Per cent second harmonic distortion is given by the following formula in which I₀ = the trial value of d-c plate current.

$$\text{Per cent 2nd Harmonic Distortion} = \frac{\frac{I \text{ max.} + I \text{ min.}}{2} - I_0}{I \text{ max.} - I \text{ min.}} \times 100$$

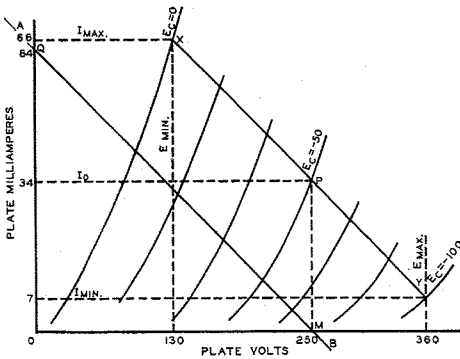

Fig. 8

Substituting values from curves in above power formula:

$$\text{Power Output} = \frac{(66-7) \times (360-130)}{8} = 1700 \text{ milliwatts}$$

Substituting values from curves in above distortion formula:

$$\text{2nd Harmonic Distortion} = \frac{\frac{0.066 + 0.007}{2} - 0.034}{0.066 - 0.007} \times 100 = 4.2\%$$

Example: Determine the undistorted power output of a 3-electrode tube at a plate voltage of 250 volts, a plate current of 34 milliamperes, a negative grid voltage of 50 volts and a plate load of 3900 ohms; given the plate characteristic curves as shown.

Procedure: Draw through point (P) which represents proposed operating conditions, line XY with slope corresponding to 3900 ohm load. This may be done by drawing XY parallel to line AB. The line AB is drawn between point (M) at 250 volts and zero current, and point (Q) at zero volts and current equal to 250 volts divided by plate load of 3900 ohms, i.e., $250 \div 3900 = 0.064$ ampere or 64 milliamperes.

THE RCA RADIOTRON MANUAL

It is customary to make the final selection of load resistance such that the distortion as calculated above does not exceed 5 per cent, a value which experience has shown to be permissible. Several approximations of load resistance may be necessary to obtain the optimum value for the trial value of plate current. Ordinarily, the plate load resistance for optimum conditions is approximately equal to twice the plate resistance.

To check the trial plate current, calculations should be made for d-c plate currents above and below the trial value. The most suitable value with its corresponding grid bias can then be selected, unless the value is higher than that recommended for the tube. In this event the maximum permissible value is chosen.

A **super-control amplifier** tube is a modified construction of the screen grid type and is designed to reduce cross-talk and cross-modulation in radio-frequency stages. Cross-talk and cross-modulation are the effects produced in a radio receiver by an interfering station "riding through" on the carrier of the station to which the receiver is tuned. This effect is caused by the radio-frequency amplifiers acting partially as detectors where very powerful signals are received or where the grid

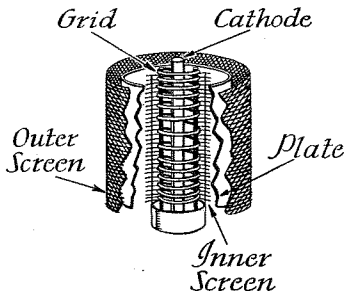

Fig. 9

bias has been increased to reduce volume. The offending tube is usually the first radio-frequency amplifier, although other stages may contribute to the trouble, particularly if the set selectivity is poor. The characteristics of super-control types are such as to enable the tube to handle both large and small input signals with minimum distortion over a wide range. This feature is obtained by a special tube structure which makes possible variation in amplification factor with a change in grid bias. A cross-section of the structure of a typical super-control tube is shown in Fig. 9. This type differs from the usual screen grid tube chiefly in the construction of the control grid which is wound with uneven spacing at the middle and close spacing at the ends. When weak signals and low grid bias are applied to the tube, the effect of the non-uniform turn spacing of the grid on cathode emission and tube characteristics is essentially the same as for a uniform spacing. As the grid bias is made more negative to handle larger input signals, the electron flow from the sections of the cathode enclosed by the ends of the grid is cut off. The plate current and other tube characteristics are then dependent on the electron flow through the coarse section of the grid. This action changes the tube characteristics so that large signals may be handled with minimum distortion due to cross-modulation and modulation effects. Fig. 10 shows typical grid voltage vs. plate current curves for a screen-grid and a super-control tube, respectively. It will be noted that while the curves are alike at small grid bias voltages, the plate current of the super-control tube drops quite slowly with large values of bias voltage. This slow change makes it possible for the tube to handle large signals satisfactorily. Since super-control types can handle a large signal range, they are particularly suitable for use in sets having automatic volume control.

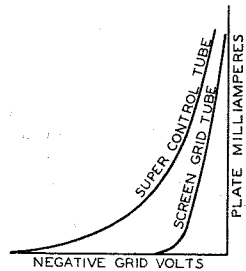

Fig. 10

Class B power amplifiers for audio applications are a new development of much interest where large power output is required. In Class B service the tube is operated so that the plate current is practically zero with no grid excitation. When a signal of sufficient magnitude is applied to the grid, there will be no plate current flow over a substantial part of the negative half-cycle. In other words, plate current flows only during the least negative excursions of the signal voltage. A considerable amount of second and higher even-ordered harmonic distortion is thus introduced

THE RCA RADIOTRON MANUAL

into the power output of a single tube. However, with two tubes in a balanced push-pull circuit, the even harmonics are eliminated from the power output. In such a circuit, therefore, two tubes may be employed as Class B amplifiers to supply virtually undistorted output.

In Class B service, it is possible to drive the grids of the two amplifier tubes positive by a certain amount and still obtain reasonably undistorted output, provided that sufficient input power is available to supply the grid current required by the positively charged grids. This power is conveniently supplied by the usual power amplifier feeding the grids of the output tubes through a push-pull transformer having the proper characteristics. Usually this transformer has a step-down ratio.

By designing Class B amplifier tubes with a sufficiently high amplification factor, it is possible to operate them with zero grid bias, and so dispense with biasing resistors whose effect would be to produce considerable loss in sensitivity because of degeneration. Since provision for grid bias is unnecessary with such tubes, the entire voltage of the rectifier is available for plate supply.

Distinguishing features of this class of service are that very high output of good quality may be obtained with fairly small tubes operating at relatively low plate voltage; and that unusual overall economy of power consumption is possible because the plate current is very low when no signal is applied to the grid. To give these advantages, the Class B amplifier circuit requires the use of two tubes in a balanced output stage preceded by a driver stage capable of delivering considerable undistorted power; and the use of a power supply capable of maintaining good voltage regulation regardless of the variation of average plate current with signal intensity. It should be noted that the distortion present in the power output of Class B amplifiers is usually negligible but is always somewhat higher for the ordinary range of signals than that obtained with usual methods of audio amplification employing much larger tubes capable of the same maximum power output.

Class B amplifiers, however, have the distinct advantage of providing, with relatively small tubes, a reserve of power-delivering ability to meet requirements for an extended volume range.

DETECTION

Detection is the separation of speech or music from the incoming radio wave. This wave consists of a radio-frequency carrier which has been modulated at the transmitter by sounds (audio frequencies). The effect of modulation is to vary the amplitude of the carrier wave in proportion to the audio input variations. Since the carrier wave is alternating, it may be considered to consist of two halves, each of which is affected equally by the audio modulation. The audio component in one-half of the carrier wave is continuously offset by the audio component in the other half of the wave at a rate equal to the carrier frequency, a frequency much too high to affect any audio system. If, however, one-half of the carrier wave can be eliminated, the audio variations in the other half of the carrier may be utilized to operate a pair of headphones or a loudspeaker (Fig. 11).

The elimination of the neutralizing effect of one-half of the carrier wave is the function of the detector. It rectifies the carrier and extracts from the rectified output, the audio component or signal. The high-frequency radio component is usually by-passed from the plate circuit of the detector tube by means of a small condenser, while the audio component is fed to the audio amplifier stage.

Two different methods of detection with radio tubes are commonly employed. These are known as the grid bias method and the grid leak and condenser method.

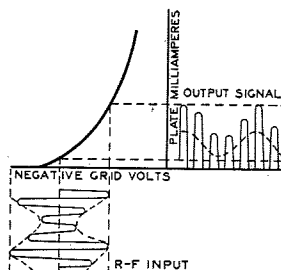

Fig. 11

THE RCA RADOTRON MANUAL

The *grid bias* method makes use of a tube which is operated with a grid bias such that the plate current with no signal is practically zero. When a signal is applied to the grid, rectification of the carrier occurs, since only the positive half is amplified. Fig. 12 illustrates this circuit.

The *grid leak and condenser* method is somewhat more sensitive than the grid bias method and gives its best results on small signals. This method uses a grid leak and condenser in the grid circuit (as shown in Fig. 13). The grid leak establishes the grid bias while the condenser offers a low resistance path to the grid for the radio-frequency input. In this circuit a high value of grid resistor gives greatest sensitivity, but improved tone and stability are obtained with lower values.

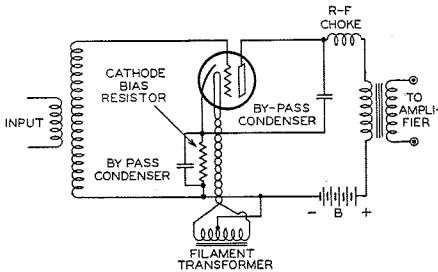

Fig. 12

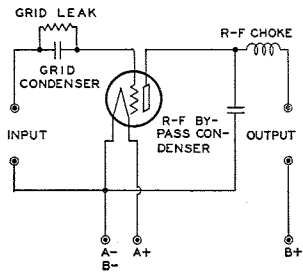
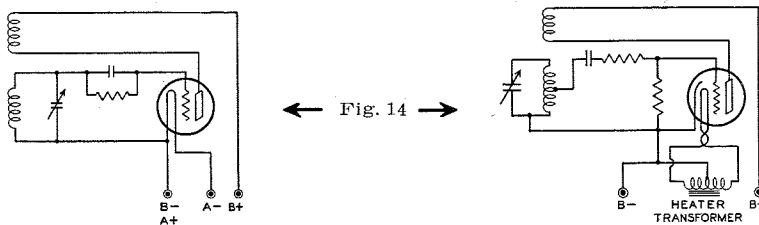

Fig. 13

Automatic volume control of receiver volume is obtained by utilizing the detecting or rectifying action of a tube to supply grid bias voltage for the radio-frequency amplifier stages. In this application, an increase in audio signal produces an increased rectified current, which is utilized to increase the grid bias on the radio-frequency tubes so that the volume is reduced to normal. This function may be combined with audio detection in one combination of tube elements, although greater flexibility in circuit design can be obtained by using two or more sets of tube elements, each operating under the optimum circuit conditions for its purpose.

OSCILLATION

As an oscillator, a radio tube can be employed to generate a continuously alternating voltage. In present-day radio broadcast receivers, this application is limited practically to its use in superheterodyne receivers for supplying the heterodyning frequency. Several circuits (represented in Fig. 14) may be utilized, but they all



← Fig. 14 →

depend on feeding more energy from the plate or output circuit to the grid or input circuit than is required to equal the power loss in the tube. Feed-back may be produced by electrostatic or electromagnetic coupling between the input and output circuits. When sufficient feed-back occurs to more than equal the tube losses, the tube will oscillate. The action consists of regular surges of power between the plate and the grid circuit at a frequency dependent on the circuit constants of inductance and capacity. By properly choosing these values, the frequency may be adjusted over very wide limits.

Installation

The installation of radio tubes requires care if high quality performance is to be obtained from the associated radio circuits. Installation suggestions and precautions which are generally common to all types of tubes are covered in this section. Careful observance of these suggestions will do much in helping the experimenter and radio technician to obtain the full performance capabilities of radio tubes and circuits. Additional and pertinent information is given under each tube type on pages 22 to 83.

FILAMENT AND HEATER POWER SUPPLY

The voltage supply for the filament or heater of radio tubes may be a battery (or other direct current source), or the alternating current power line, depending on the type of tube. Frequently, a regulating resistor is used with the d-c supply to adjust the tube voltage at the filament terminals of the socket to the correct value and to compensate for battery voltage variations. Ordinarily, a step-down transformer is used with a-c supply to provide the proper voltage at the filament terminals. The primary of this transformer may be tapped to permit of adjustment for line voltage variation.

The design of radio tubes allows for a small variation in voltage supplied to the filament or heater, but most satisfactory results are obtained from operation at the rated value. When the voltage is low, the temperature of the cathode is below normal, with the result that electron emission is limited. This may cause reduced life and unsatisfactory operation. On the other hand, high filament voltage causes evaporation of cathode material and shortened tube life. The filament voltage should be checked at the socket terminals by means of an accurate voltmeter while the tube is in operation.

For *voltage adjustment* with d-c supply, a variable or a fixed resistor is used in series with the filament (or heater) and the power source. In the case of dry battery supply, it is also recommended that an accurate voltmeter or milliammeter be permanently installed in the receiver to insure operation of the tubes at their rated filament voltage. Turning the set on and off by means of the rheostat is advised to prevent over-voltage conditions after an off-period. The voltage of dry-cells recuperates during off periods. In the case of storage battery supply, air-cell battery supply, or d-c power supply, a fixed resistor is permissible. If an adjustable resistor is used, no further adjustment is necessary after the initial setting by meter test.

The size of the resistance required for any particular condition can be determined easily by a simple formula (Ohm's law).

$$\text{Required Resistance (ohms)} = \frac{\text{Supply volts} - \text{Rated volts of tube type}}{\text{Total rated filament current of tubes}}$$

Thus, if it is required to operate from dry batteries a receiver using three '32's, two '30's, and two '31's, the series resistor is equal to 3 volts (the voltage from two dry cells in series) minus 2 volts (voltage rating for these tubes) divided by 0.56 ampere (the sum of 5×0.060 ampere + 2×0.130 ampere), i.e., approximately 1.8 ohms. Since this resistor should be variable to allow adjustment for battery depreciation, it is advisable to obtain the next larger commercial size, although any value between 2 and 3 ohms will be quite satisfactory. Where much power is dissipated in the resistor, the wattage rating should be sufficiently large to prevent overheating. The power dissipation in watts is equal to the voltage drop in the resistor multiplied by the total filament current in amperes. Thus, for the example above, $1 \times 0.56 = 0.56$ watts. In this case, the value is so small that any commercial rheostat having suitable resistance will be adequate.

Series operation of the heaters of the '36, '37, '38 and '39 is permissible for receivers which operate on direct current power lines. Under these conditions, the resistor required in series with the tube heaters is equal to the line voltage minus the sum of the tube voltages divided by the heater current (in amperes) of a single tube. Other types of tubes may be operated with filaments or heaters in series,

THE RCA RADIOTRON MANUAL

but it is important that the filament or heater current for tubes so connected be of the same rating.

A-c filament supply is ordinarily obtained from a step-down transformer. Precautions should be taken to see that the line voltage is the same as that for which the primary of the transformer is designed. The line voltage may be determined by measurement with an a-c voltmeter (0-150 volts) of good quality.

If the line voltage measures in excess of that for which the transformer is designed, a resistor should be placed in series with the primary to reduce the line voltage to the rated value of the transformer primary. Unless this is done, the excess input voltage will cause proportionally excessive voltage to be applied to the tubes. Any radio tube may be damaged or made inoperative by excessive operating voltages.

If the line voltage is consistently below that for which the primary of the transformer is designed, it may be necessary to install a booster transformer between the a-c outlet and the transformer primary. Before such a transformer is installed, the a-c line fluctuations should be very carefully noted. Many radio sets are equipped with a line voltage switch which permits adjustment of the power transformer primary to the line voltage. When this switch is properly adjusted, the series-resistor or booster-transformer method of controlling line voltage is seldom required.

PLATE VOLTAGE SUPPLY

The plate voltage for radio tubes ordinarily is obtained from batteries or from a rectified a-c supply. The maximum plate voltage value for any tube type should not be exceeded if most satisfactory performance is to be obtained. Plate voltage should not be applied to a tube unless the corresponding recommended grid voltage is also supplied to the grid.

GRID VOLTAGE SUPPLY

The recommended grid voltages for different operating conditions have been carefully determined to give the most satisfactory performance. Grid voltage may be obtained from a separate C-battery, a tap on the voltage divider of the high voltage d-c supply, or from the voltage drop across a resistor in the cathode circuit. This last is called the "self-bias" method, since the cathode current of each tube is utilized to produce the bias voltage. In any case, the object of the connection is to make the grid negative with respect to the cathode by the specified voltage. With C-battery supply, the negative battery terminal is connected to the grid return. The positive terminal is connected to the negative filament socket terminal, or to the cathode terminal if the tube is of the heater-cathode type. If the filament is supplied with alternating current, this connection is usually made to the center-tap of a low resistance (20-50 ohms) shunted across the filament terminals. This method reduces hum disturbances caused by the a-c supply. If bias voltages are obtained from the voltage divider of a high voltage d-c supply, the grid return is tied into a more negative tap than the cathode.

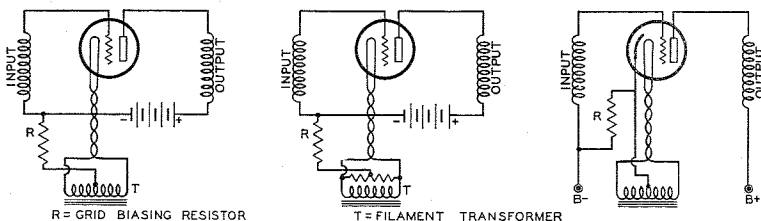

Fig. 15

THE RCA RADIOTRON MANUAL

The *self-biasing* method is accomplished by utilizing the voltage drop produced by the cathode current flowing through a resistor (Fig. 15) connected between the cathode and the negative terminal of the B-supply. The cathode current is, of course, equal to the plate current for a triode or to the sum of the plate and screen current for a tetrode and a pentode. Since the voltage drop along the resistance is increasingly negative with respect to the cathode, the required negative grid bias voltage can be obtained by connecting the grid return to the negative end of the resistance.

The size of the resistance for self-biasing a single tube can be determined from the following formula:

$$\text{Resistance (ohms)} = \frac{\text{Desired grid bias voltage} \times 1000}{\text{Rated plate current in milliamperes}}$$

Thus, the size of resistance required to produce 9 volts bias for a tube which operates at 3 milliamperes plate current is $9 \times 1000/3 = 3000$ ohms. If the cathode current of more than one tube passes through the resistor, the size of the resistor will be determined by the total current. As indicated above for screen grid tubes or pentodes, the cathode current is the sum of the screen and the plate current.

Grid voltage variation for the r-f amplifier stages is a convenient and frequently used method for controlling receiver volume. The variable voltage supplied to the grid is obtained either from a bleeder circuit by means of a potentiometer, or by the self-bias method using a variable resistor. In either case, it is important that the control be arranged so that less than the minimum recommended grid bias voltage cannot be applied to the grid. This requirement may be met by a stop on the potentiometer or by a fixed resistance in series with the variable section. See Fig. 16.

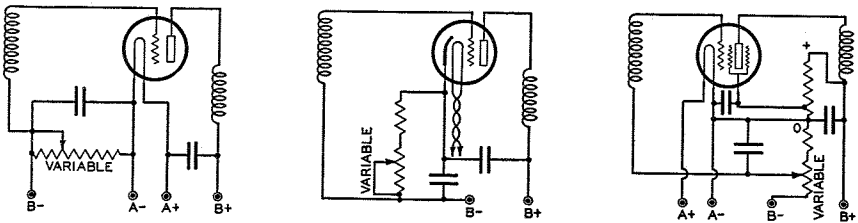

Fig. 16

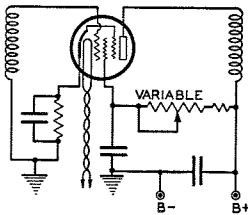

Fig. 17

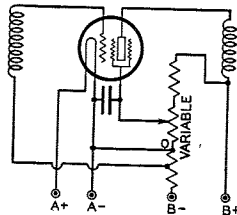

Fig. 18

SCREEN VOLTAGE SUPPLY

The positive voltage for the screen connection of a radio tube is usually obtained from a tap on the B-supply. The screen voltage of screen grid types of the four-electrode (or tetrode) construction, should be obtained by connecting the

THE RCA RADIOTRON MANUAL

screen either direct to the proper voltage tap or through a potentiometer connected across the B-supply, but never through a series resistance to a high voltage supply. This latter arrangement will not usually be satisfactory because of screen current variations. Tubes of the pentode construction, however, may utilize the series resistor arrangement, since this construction makes possible greater uniformity of the screen current characteristic. See Fig. 17.

Screen voltage variation for the r-f amplifier stages is sometimes used for volume control of the receiver. Reduced screen voltage lowers the mutual conductance of the tube and results in decreased gain per stage. The voltage variation is obtained by means of a potentiometer shunted across the screen grid voltage supply. See Fig. 18.

SHIELDING

Circuits employing tubes having high gain capabilities, particularly screen grid types, require shielding by metal enclosures if stable operation and high gain per stage is to be obtained. In multi-tube r-f amplifier circuits, it is necessary to shield completely and effectively each stage and to include within the stage shield the coupling device. Unless the coils and condensers of the various stages are shielded from each other, the amplification possibilities of the tubes and their circuits cannot be realized.

Since coupling between stages can occur not only from interaction of stage coupling devices, but also from a common voltage supply circuit, it is advisable to employ filters in all voltage supply leads entering the stage shields. A filter, in order to be effective, should have a high impedance to the frequencies handled by the stage. Radio-frequency filters require the use of high-grade by-pass condensers for most satisfactory results. See Fig. 19 for various filter arrangements.

OUTPUT COUPLING DEVICES

An output coupling device is used in the plate circuit of a power output tube to keep its comparatively high d-c plate current from the winding of an electro-magnetic speaker driving unit, and to transfer power efficiently from the output stage to a loudspeaker.

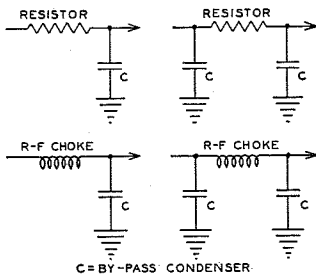

Fig. 19

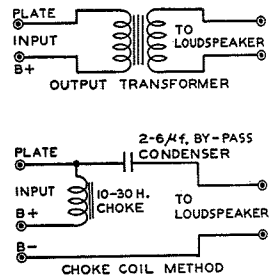

Fig. 20

Output coupling devices are of two types, (1) choke condenser and (2) transformer. The choke-condenser type consists of an iron-core choke coil with an inductance of not less than 12 henrys which is placed in series with the plate and B-supply. The choke offers a very low resistance to the d-c plate current but opposes the flow of the fluctuating signal voltage. A by-pass condenser of 2 to 4 $\mu\text{f.}$ supplies a path to the speaker winding for the signal voltage. The transformer type is constructed with two separate windings, a primary and a secondary wound on an iron core. This construction permits of designing each winding to meet the requirements of its position in the circuit. Typical arrangements of each type of coupling device are shown in Fig. 20.

RCA Radiotron

UX-201-A

DETECTOR, AMPLIFIER

The '01-A is a three-electrode storage battery tube for use as a detector and as an amplifier.



CHARACTERISTICS

FILAMENT VOLTAGE (D. C.)	5.0	Volts
FILAMENT CURRENT	0.25	Ampere
PLATE VOLTAGE	90	135 max. Volts
GRID VOLTAGE	-4.5	-9 Volts
PLATE CURRENT	2.5	3.0 Milliampere
PLATE RESISTANCE	11000	10000 Ohms
AMPLIFICATION FACTOR	8	8
MUTUAL CONDUCTANCE	725	800 Micromhos
GRID-PLATE CAPACITANCE		8.1 μ f.
GRID-FILAMENT CAPACITANCE		3.1 μ f.
PLATE-FILAMENT CAPACITANCE		2.2 μ f.
MAXIMUM OVERALL LENGTH		4 $\frac{1}{16}$ "
MAXIMUM DIAMETER		1 $\frac{3}{16}$ "
BULB (See page 42, Fig. 8)		S-14
BASE		Medium 4-Pin

INSTALLATION

The base pins of the '01-A fit the standard four-contact socket. The socket should be installed so that the tube will operate in a vertical position. Cushioning of the socket in the detector stage may be desirable if microphonic disturbances are encountered. For socket connections, see page 39, Fig. 1.

The filament in the '01-A is intended for operation from a 6-volt storage battery. A fixed or variable resistor of suitable value is required to reduce the battery voltage to 5.0 volts across the filament terminals at the socket. At this voltage, the most satisfactory operating performance will be obtained.

APPLICATION

As a detector, the '01-A may be operated either with grid leak and condenser or with grid bias. The recommended plate voltage for the former method is 45 volts. A grid leak of from 1 to 5 megohms used with a grid condenser of 0.00025 μ f. is suitable. The grid circuit return should be connected to the positive filament terminal. For grid bias detection, plate voltages up to the maximum value of 135 volts may be used with the corresponding negative grid bias voltage (13.5 volts approximately).

As an amplifier, the '01-A is applicable to the audio- or the radio-frequency stages of a receiver. Plate voltages and the corresponding grid voltages for audio amplifier service should be determined from the tabulated characteristics and the curves in order to obtain optimum performance and freedom from distortion. The higher plate voltages will be found advantageous under conditions where the impressed signal is large or where maximum voltage output is desired.

When the '01-A is used as a radio-frequency amplifier, little is gained from the use of plate voltages exceeding 90 volts. The '01-A is well adapted for use as an interstage audio-frequency amplifier but a power output tube is recommended for the final audio stage.

Volume control of the receiver may be accomplished by variation of either the grid bias or the plate voltage applied to the radio-frequency stages.

THE RCA RADIOTRON MANUAL

AVERAGE PLATE CHARACTERISTICS

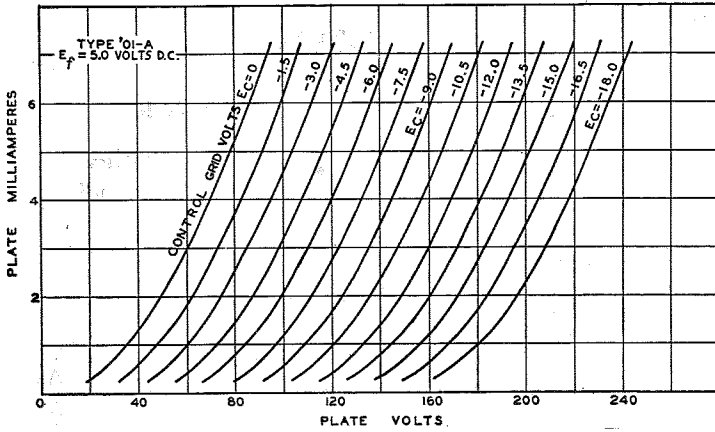

AVERAGE CHARACTERISTICS

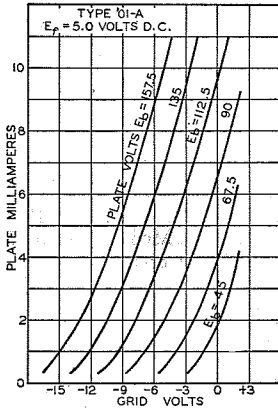

AVERAGE CHARACTERISTICS

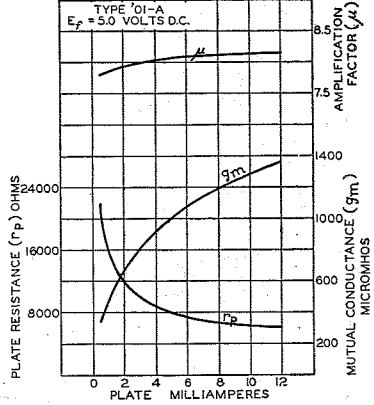

AVERAGE PLATE CHARACTERISTICS

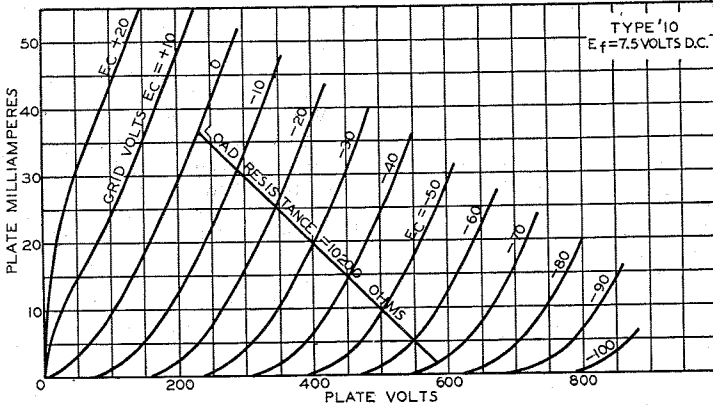

RCA Radiotron

RCA-210

POWER AMPLIFIER, OSCILLATOR



The type '10 is a three-electrode high-vacuum tube suitable for power amplifier use. As an audio-frequency amplifier, it is capable of delivering large undistorted output to the loudspeaker.

CHARACTERISTICS

FILAMENT VOLTAGE (A. C. or D. C.)	7.5	Volts
FILAMENT CURRENT	1.25	Amperes
PLATE VOLTAGE	250 350 425 <i>max.</i>	Volts
GRID VOLTAGE*	-22 -31 -39	Volts
PLATE CURRENT	10 16 18	Milliamperes
PLATE RESISTANCE	6000 5150 5000	Ohms
AMPLIFICATION FACTOR	8 8 8	
MUTUAL CONDUCTANCE	1330 1550 1600	Micromhos
LOAD RESISTANCE	13000 11000 10200	Ohms
UNDISTORTED POWER OUTPUT	400 900 1600	Milliwatts
GRID-PLATE CAPACITANCE	8	μ f.
GRID-FILAMENT CAPACITANCE	5	μ f.
PLATE-FILAMENT CAPACITANCE	4	μ f.
MAXIMUM OVERALL LENGTH		5 $\frac{5}{8}$ "
MAXIMUM DIAMETER		2 $\frac{3}{16}$ "
BULB (See page 42, Fig. 10)		S-17
BASE		Medium 4-Pin Bayonet

* Grid voltages are given with respect to the mid-point of filament operated on a.c. If d.c. is used, each stated value of grid voltage should be decreased by 3.75 volts and should be referred to the negative end of the filament.

INSTALLATION

The base pins of the '10 fit the standard four-contact socket. The socket should be installed so that the tube will operate in a vertical position with the base down. For socket connections, see page 39, Fig. 1.

The filament of the type '10 is usually operated from the a-c line through a step-down transformer. Most satisfactory operating performance of the tube will be obtained at the rated filament voltage.

With an a-c filament supply, the grid and the plate return should be brought either to a mid-tapped resistor of 20 to 40 ohms across the filament winding, or to a mid-tap on the filament winding itself. With a d-c filament supply, the grid and the plate return should be made to the negative filament terminal.

Grid bias for the type '10 may be obtained from a C-supply or by means of the voltage drop in a resistor connected in the negative plate return lead. The latter method is known as the self-biasing method, since the plate current determines the drop. It is not, however, generally applicable to battery-operated receivers.

APPLICATION

As an audio power amplifier this tube should be operated under conditions as given under CHARACTERISTICS. To prevent overloading and distortion, the recommended grid bias should always be used. Average plate characteristics (curves) are given on the preceding page.

RCA Radiotron

UX-112-A

DETECTOR, AMPLIFIER

The 112-A is an improved storage battery tube. It is sensitive as a detector and excellent as a three-electrode radio-frequency and audio-frequency amplifier.



CHARACTERISTICS

FILAMENT VOLTAGE (D. C.).....	5.0	Volts
FILAMENT CURRENT	0.25	Ampere
PLATE VOLTAGE	90 135 180 <i>max.</i>	Volts
GRID VOLTAGE	-4.5 -9 -13.5	Volts
PLATE CURRENT	5.2 6.2 7.6	Milliamperes
PLATE RESISTANCE	5600 5300 5000	Ohms
AMPLIFICATION FACTOR	8.5 8.5 8.5	
MUTUAL CONDUCTANCE	1500 1600 1700	Micromhos
LOAD RESISTANCE	5600 8700 10800	Ohms
UNDISTORTED POWER OUTPUT	30 115 260	Milliwatts
GRID-PLATE CAPACITANCE	8.1	μ mf.
GRID-FILAMENT CAPACITANCE	4.2	μ mf.
PLATE-FILAMENT CAPACITANCE	2.1	μ mf.
MAXIMUM OVERALL LENGTH		4 $\frac{11}{16}$ "
MAXIMUM DIAMETER		1 $\frac{13}{16}$ "
BULB (See page 42, Fig. 8)		S-14
BASE		Medium 4-Pin

INSTALLATION

The base pins of the 112-A fit the standard four-contact socket. The socket should be installed so that the tube will operate in a vertical position. Cushioning of the socket in the detector stage may be desirable if microphonic disturbances are encountered. For socket connections, see page 39, Fig. 1.

The coated filament employed in the 112-A may be operated conveniently from a 6-volt storage battery. A fixed or variable resistor of suitable value is required to reduce the battery voltage to 5.0 volts across the filament terminals at the socket. At this voltage, the most satisfactory operating performance will be obtained.

APPLICATION

As a **detector**, the 112-A may be operated either with grid leak and condenser or with grid bias. The recommended plate voltage for the former method is 45 volts. A grid leak of from 0.25 to 5 megohms used with a grid condenser of 0.00025 μ f. is suitable. The grid circuit return should be connected to the positive filament terminal.

For grid bias detection, plate voltages up to the maximum value of 180 volts may be used. The corresponding grid bias should be adjusted so that the plate current, when no signal is being received, is about 0.2 milliampere. Usually, a plate voltage of 135 volts with a grid bias of approximately -15 volts will be satisfactory.

As an **amplifier**, the 112-A is applicable to the audio or the radio-frequency stages of a receiver. Plate voltages and the corresponding grid voltages for audio amplifier service should be determined from the tabulated characteristics and the curves in order to obtain optimum performance and freedom from distortion. The

THE RCA RADIOTRON MANUAL

higher plate voltages will be found advantageous under conditions where the impressed grid signal is large or where maximum power output is desired.

When the 112-A is used as a radio-frequency amplifier, little is gained from plate voltages exceeding 90 volts. If the 112-A is substituted for the '01-A in radio-frequency circuits, it may be necessary to readjust the neutralizing condensers or to increase the value of the grid suppressor resistors to prevent oscillation.

Volume Control of the receiver may be accomplished by variation either of the grid bias or the plate voltage applied to the radio-frequency stages.

AVERAGE PLATE CHARACTERISTICS

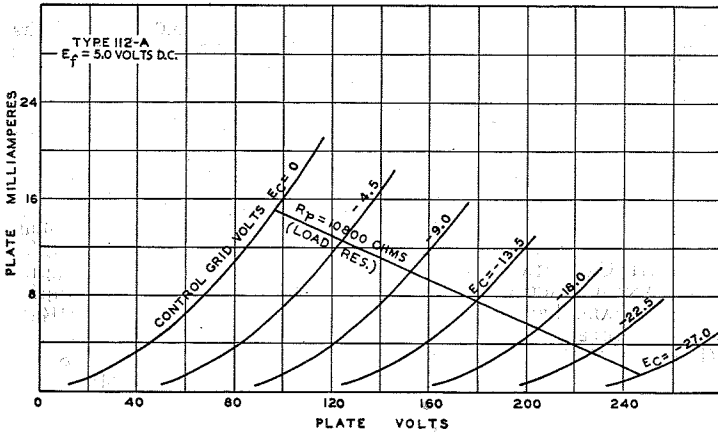

AVERAGE CHARACTERISTICS

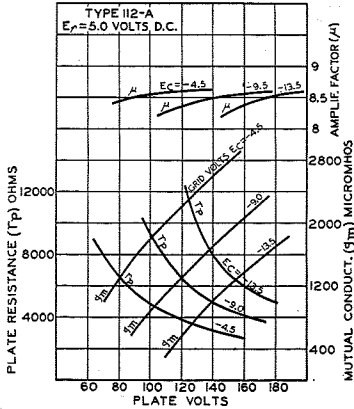

AVERAGE CHARACTERISTICS

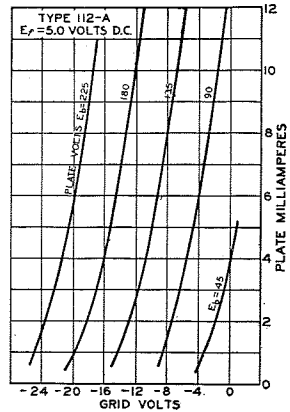

RCA Radiotron

UX-120

POWER AMPLIFIER



The '20 is a three-electrode, high-vacuum, power amplifier tube designed for operation from dry-cells. It is intended for use in the last audio stage of dry-battery-operated receivers using the '99 and/or '22.

CHARACTERISTICS

FILAMENT VOLTAGE (D. C.).....	3.0-3.3	Volts
FILAMENT CURRENT	0.125-0.132	Ampere
PLATE VOLTAGE	135 max.	Volts
GRID VOLTAGE	-22.5	Volts
PLATE CURRENT	3.0	Milliamperes
PLATE RESISTANCE	8000	Ohms
AMPLIFICATION FACTOR	3.3	
MUTUAL CONDUCTANCE	415	Micromhos
LOAD RESISTANCE	9600	Ohms
UNDISTORTED POWER OUTPUT	45	110
GRID-PLATE CAPACITANCE	4.1	μuf.
GRID-FILAMENT CAPACITANCE	2.0	μuf.
PLATE-FILAMENT CAPACITANCE	2.3	μuf.
MAXIMUM OVERALL LENGTH		4 1/8"
MAXIMUM DIAMETER		1 3/16"
BULB (See page 42, Fig. 1)		T-8
BASE		Small 4-Pin

INSTALLATION

The base pins of the '20 fit the standard four-contact socket. The socket should be installed to operate the tube in a vertical position. For socket connections, see page 39, Fig. 1.

The filament in this tube is designed for operation with three No. 6 dry-cells connected in series. In multi-tube receivers the use of six or nine No. 6 dry-cells connected in series-parallel to give 4.5 volts will decrease the current drain per cell and give a more stable source of filament power. If storage battery operation is preferred, a four-volt storage battery may be used. In any case, a filament rheostat should be provided to maintain the voltage applied to the filament within the stated range.

APPLICATION

For power amplifier service, the '20 will give greatest power output when operated at a plate voltage of 135 volts and the corresponding grid bias of -22.5 volts. At 90 volts on the plate and with a corresponding grid bias of -16.5 volts, good quality of reproduction may be obtained at a lower level of power output.

In receivers employing tubes of the 3.3 volt filament type, the use of the '20 in the output stage will be found desirable.

RCA Radiotron

UX-222



SCREEN GRID RADIO-FREQUENCY AMPLIFIER

The '22 is a screen grid tube designed particularly for radio-frequency amplification in dry-battery-operated receivers employing 3.3 volt filament tubes.

CHARACTERISTICS

FILAMENT VOLTAGE (D. C.)	3.3	Volts
FILAMENT CURRENT	0.132	Ampere
PLATE VOLTAGE	135	Volts
	135 <i>max.</i>	Volts
GRID VOLTAGE	-1.5	Volts
	-1.5	Volts
SCREEN VOLTAGE	45*	Volts
	67.5**	Volts
PLATE CURRENT	1.5	Milliamperes
	3.3	Milliamperes
SCREEN CURRENT	Not over $\frac{1}{3}$ of plate current	
PLATE RESISTANCE	850000	Ohms
	600000	Ohms
AMPLIFICATION FACTOR	300	
	290	
MUTUAL CONDUCTANCE	350	Micromhos
	480	Micromhos
EFFECTIVE GRID-PLATE CAPACITANCE	0.025 <i>maximum</i>	$\mu\text{mf.}$
INPUT CAPACITANCE	3.2	$\mu\text{mf.}$
OUTPUT CAPACITANCE	12	$\mu\text{mf.}$
OVERALL LENGTH		$4\frac{25}{32}$ " to $5\frac{1}{32}$ "
MAXIMUM DIAMETER		$1\frac{13}{16}$ "
BULB (See page 42, Fig. 11)		S-14
CAP		Small Metal
BASE		Medium 4-Pin

* Maximum value of grid resistor is 5.0 megohms.

** Maximum value of grid resistor is 1.0 megohm.

INSTALLATION

The base pins of the '22 fit the standard four-contact socket. The socket should be installed to hold the tube in a vertical position. Cushioning of the socket may be desirable to avoid microphonic disturbances. For socket connections, see page 39, Figure 4.

For filament operation, refer to INSTALLATION for type '20.

APPLICATION

As a **radio-frequency amplifier** in multi-stage circuits, it is necessary to shield carefully each stage and to include within the stage shield all of the component parts of that stage. Unless this is done, the amplification possibilities of the '22 cannot be realized.

As an **audio-frequency amplifier**, this tube may be operated with either the screen-grid or space-charge-grid connection. In either case, the value of plate coupling resistor should be of from 100000 to 250000 ohms. With the screen-grid arrangement, a plate supply voltage of 135 to 180 volts applied through the coupling resistor is recommended. Under these conditions, a screen voltage of 22.5 volts and a negative grid voltage of 0.75 to 1.5 volts are suitable. For the space-charge-grid connection, the inner grid is operated at 22.5 volts, while the outer grid becomes the control grid and is biased negatively by from 0 to 1.5 volts, depending upon conditions of operation.

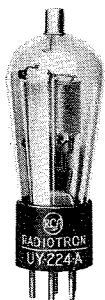

RCA Radiotron

UY-224-A

SCREEN GRID RADIO-FREQUENCY AMPLIFIER

The '24-A is a screen grid amplifier tube containing a 2.5 volt uni-potential heater-cathode which permits operation from alternating current. This tube is recommended for use primarily as a radio-frequency amplifier in carefully shielded circuits especially designed for it. The '24-A may also be used as a screen grid detector or audio amplifier.

CHARACTERISTICS

HEATER VOLTAGE (A. C. or D. C.)	2.5	Volts	
HEATER CURRENT	1.75	Amperes	
PLATE VOLTAGE*	180	250	Volts
GRID VOLTAGE	-3	-3	Volts
SCREEN VOLTAGE	90	90 max.	Volts
PLATE CURRENT	4	4	Milliamperes
SCREEN CURRENT		Not over $\frac{1}{3}$ of	plate current
PLATE RESISTANCE	400000	600000	Ohms
AMPLIFICATION FACTOR	400	615	
MUTUAL CONDUCTANCE	1000	1025	Micromhos
EFFECTIVE GRID-PLATE CAPACITANCE		0.01 maximum	$\mu\text{mf.}$
INPUT CAPACITANCE		5.0	$\mu\text{mf.}$
OUTPUT CAPACITANCE		10.0	$\mu\text{mf.}$
OVERALL LENGTH			$4\frac{25}{32}$ " to $5\frac{1}{32}$ "
MAXIMUM DIAMETER			$1\frac{13}{16}$ "
BULB (See page 42, Fig. 11)			S-14
CAP			Small Metal
BASE			Medium 5-Pin

* Maximum plate voltage = 275 volts.

INSTALLATION

The base pins of the '24-A fit the standard five-contact socket. The socket may be installed to operate the tube in any position. For socket connections, see page 39, Fig. 9.

The heater of the '24-A is intended for operation from a 2.5 volt winding of the power transformer. The voltage applied to the heater terminals should be the rated value of 2.5 volts under conditions of operating load and average line voltage.

The cathode connection to the heater should be made (1) to the movable arm of a potentiometer connected across the heater winding of the power transformer, or (2) to a mid-tapped resistor across the heater winding, or (3) to the mid-point of the heater winding itself. Recommended practice is to have no voltage difference between heater and cathode. If this practice is not followed, the heater may be made negative by not more than 45 volts.

The positive screen voltage for the '24-A may be obtained from a fixed or variable tap on a voltage divider across the high voltage supply, or across a portion of the supply.

Complete shielding in all stages of the circuit is necessary if maximum gain per stage is to be obtained.

THE RCA RADIOTRON MANUAL

APPLICATION

As a **radio-frequency amplifier**, the '24-A should be operated at the voltages given under CHARACTERISTICS. Plate voltage and screen voltage are not critical. In general, properly designed radio-frequency transformers are preferable to inter-stage coupling impedances, especially in cases where a high impedance B-supply may cause oscillation below radio frequencies.

As a **detector**, the '24-A may be operated either with grid leak and condenser or with grid bias (see page 16). For grid bias detection suitable operating conditions are: plate supply voltage of 275 volts applied through a plate coupling resistor of 250000 ohms, a positive screen voltage of 20 to 45 volts, and a negative grid bias (approximately 5 volts) so adjusted that a plate current of 0.1 milliamperes is obtained with no a-c input signal. For grid leak and condenser detection, suitable operating conditions are: plate supply voltage 275 volts applied through a plate coupling resistor of 250000 ohms, a positive screen voltage of 20 to 45 volts, a grid leak of 2 to 5 megohms, and a grid condenser of 0.00025 μ f.

As a screen grid **audio-frequency amplifier** in resistance coupled circuits, the '24-A may be operated under the following conditions: plate supply voltage 250, grid bias -1 volt, screen voltage 25 volts, plate current 0.5 milliamperes (approximate), plate load resistor 0.1 to 0.25 megohm, and a grid resistor of 0.25 to 2.0 megohms.

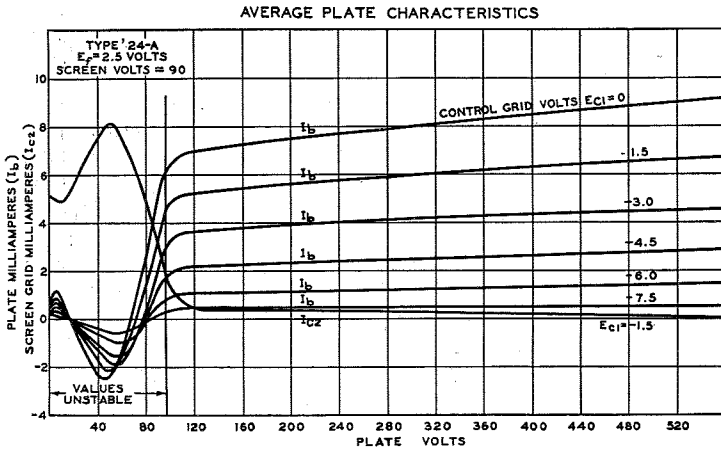

RCA Radiotron

UX-226

AMPLIFIER

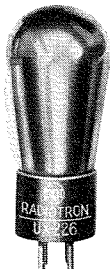

The '26 is an amplifier tube containing a filament designed for operation on alternating current. It is useful as a radio-frequency amplifier and as a transformer-coupled audio-frequency amplifier. The '26 is not ordinarily suitable for use as a detector or power output tube.

CHARACTERISTICS

FILAMENT VOLTAGE (A. C. or D. C.)	1.5	Volts
FILAMENT CURRENT	1.05	Amperes
PLATE VOLTAGE	90 135 180 <i>max.</i>	Volts
GRID VOLTAGE*	-7 -10 -14.5	Volts
PLATE CURRENT	2.9 5.5 6.2	Milliamperes
PLATE RESISTANCE	8900 7600 7300	Ohms
AMPLIFICATION FACTOR	8.3 8.3 8.3	
MUTUAL CONDUCTANCE	935 1100 1150	Micromhos
GRID-PLATE CAPACITANCE	8.1	$\mu\text{mf.}$
GRID-FILAMENT CAPACITANCE	3.5	$\mu\text{mf.}$
PLATE-FILAMENT CAPACITANCE	2.2	$\mu\text{mf.}$
MAXIMUM OVERALL LENGTH		4 $\frac{1}{4}$ "
MAXIMUM DIAMETER		1 $\frac{1}{16}$ "
BULB (See page 42, Fig. 8)		S-14
BASE		Medium 4-Pin

* Grid voltage measured from mid-point of a-c operated filament.

INSTALLATION

The base pins of the '26 fit the standard four-contact socket. The socket should be installed so that the tube will operate in a vertical position. For socket connections, see page 39, Fig. 1.

The coated filament of the '26 should be operated at the rated voltage of 1.5 volts from the a-c line through a step-down transformer. For certain applications, it may be operated with a d-c filament power source.

When the filament is a-c operated, the plate and grid return lead should be brought (1) to the movable arm of a 20 to 40 ohm potentiometer across the filament winding, or (2) to the mid-tap of the filament winding itself. When d.c. is used to operate the filament, the grid and plate returns should be connected to the negative filament terminal.

APPLICATION

As an **audio-frequency amplifier**, the '26 should be used with transformer coupling in order to secure the greatest amplification per stage.

As a **radio-frequency amplifier**, the '26 may be operated at plate voltages as low as 90 volts with good results.

THE RCA RADIOTRON MANUAL

AVERAGE PLATE CHARACTERISTICS

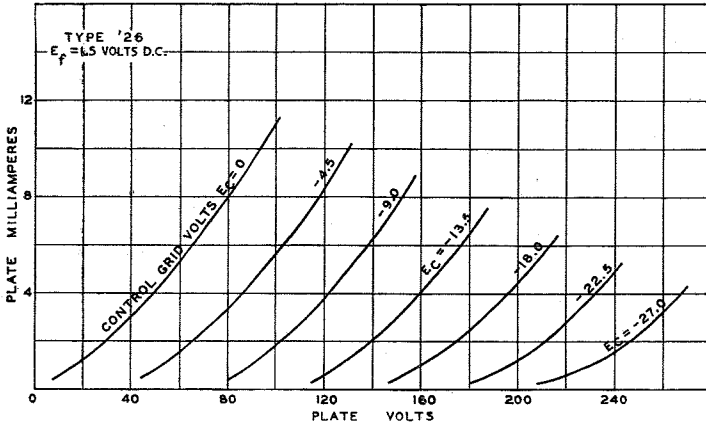

AVERAGE CHARACTERISTICS

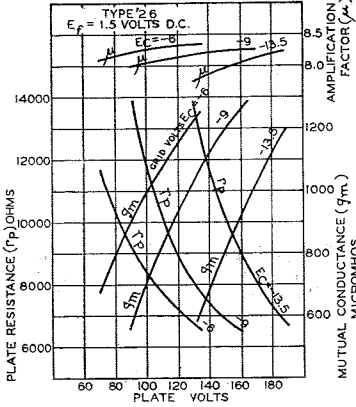

AVERAGE CHARACTERISTICS

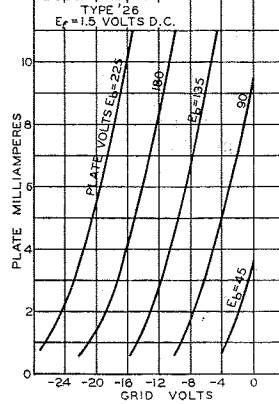

RCA Radiotron

UY-227

DETECTOR, AMPLIFIER



The '27 is a three-electrode general purpose tube containing a 2.5 volt heater-cathode of the equi-potential type which permits operation from alternating current.

CHARACTERISTICS

HEATER VOLTAGE (A. C. or D. C.)	2.5	Volts
HEATER CURRENT	1.75	Amperes
PLATE VOLTAGE*	90 135 180 250	Volts
GRID VOLTAGE	-6 -9 -13.5 -21	Volts
PLATE CURRENT	2.7 4.5 5.0 5.2	Milliamperes
PLATE RESISTANCE	11000 9000 9000 9250	Ohms
AMPLIFICATION FACTOR	9 9 9 9	
MUTUAL CONDUCTANCE	820 1000 1000 975	Micromhos
GRID-PLATE CAPACITANCE	3.3	μ mf.
GRID-CATHODE CAPACITANCE	3.5	μ mf.
PLATE-CATHODE CAPACITANCE	3.0	μ mf.
MAXIMUM OVERALL LENGTH		4 $\frac{11}{16}$ "
MAXIMUM DIAMETER		1 $\frac{13}{16}$ "
BULB (See page 42, Fig. 8)		S-14
BASE		Medium 5-Pin

* Maximum plate voltage = 275 volts.

INSTALLATION

The base pins of the '27 fit the standard five-contact socket. The socket may be mounted to hold the tube in any position. For socket connections, see page 39, Fig. 8.

The heater of the '27 is intended for operation from a 2.5 volt winding of the power transformer. The voltage applied to the heater terminals should be the rated value of 2.5 volts under conditions of operation and average line voltage.

The cathode connection to the heater should be made (1) to the movable arm of a potentiometer connected across the heater winding of the power transformer, or (2) to a mid-tapped resistor across the heater winding, or (3) to the mid-point of the heater winding itself. Recommended practice is to follow no potential difference between heater and cathode. If this practice is not followed, the heater may be biased preferably negative, but allowably positive, with respect to the cathode by not more than 45 volts.

APPLICATION

As an amplifier, the '27 is applicable to the audio- or the radio-frequency stages of a receiver. Recommended plate and grid voltages are shown under CHARACTERISTICS.

As a detector, the '27 may be operated either with grid leak and condenser or with grid bias. The recommended plate voltage for grid leak and condenser detections is 45 volts (see page 16). A grid leak of from 1 to 5 megohms used with a grid condenser of 0.00025 μ f. is suitable. For grid bias detection, a plate voltage of 250 volts or less may be used. The corresponding grid bias should be adjusted so that the plate current when no signal is being received is approximately 0.2 milliamperes. For the conditions of 250 volts on plate and transformer coupling, the grid bias will be approximately -30 volts.

THE RCA RADOTRON MANUAL

AVERAGE PLATE CHARACTERISTICS

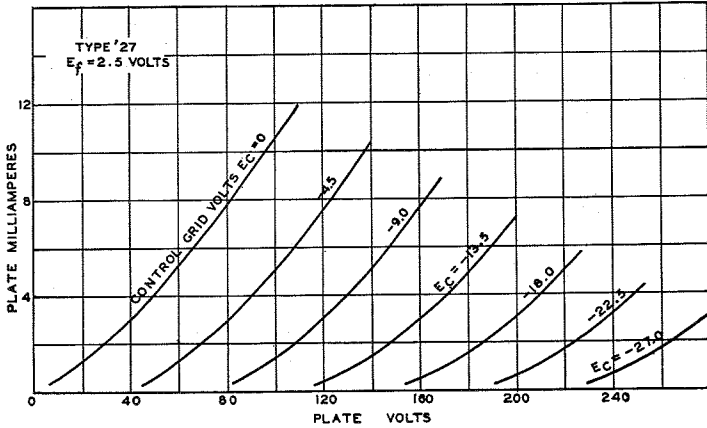

AVERAGE CHARACTERISTICS

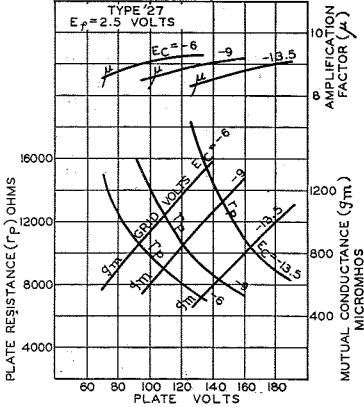

AVERAGE CHARACTERISTICS

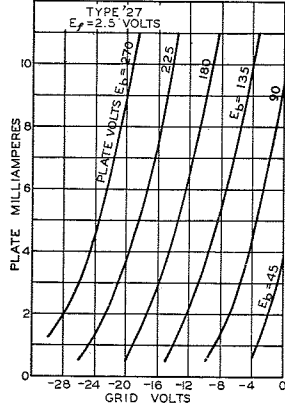

RCA Radiotron

RCA-230

DETECTOR, AMPLIFIER

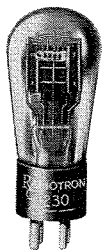

The '30 is a detector and amplifier tube of the three-electrode type. It has a coated filament which takes as little power as possible consistent with satisfactory operating performance. This feature makes the '30 particularly suitable in battery-operated radio receivers employing the '32, '34, '31, and/or '33 where economy of filament current drain is important.

CHARACTERISTICS

FILAMENT VOLTAGE (D. C.)	2.0	Volts
FILAMENT CURRENT	0.060	Ampere
PLATE VOLTAGE	180 max.	Volts
GRID VOLTAGE	-13.5	Volts
PLATE CURRENT	3.1	Milliamperes
PLATE RESISTANCE	10300	Ohms
AMPLIFICATION FACTOR	9.3	
MUTUAL CONDUCTANCE	900	Micromhos
GRID-PLATE CAPACITANCE	6.0	μ f.
GRID-FILAMENT CAPACITANCE	3.7	μ f.
PLATE-FILAMENT CAPACITANCE	2.1	μ f.
MAXIMUM OVERALL LENGTH		4 1/4"
MAXIMUM DIAMETER		1 9/16"
BULB (See page 42, Fig. 6)		S-12
BASE		Small 4-Pin

INSTALLATION

The base pins of the '30 fit the standard four-contact socket. The socket should be installed so that the tube will operate in a vertical position. Cushioning of the socket in the detector stage may be desirable if microphonic disturbances are encountered. For socket connections, see page 39, Fig. 1.

The coated filament of the '30 may be operated conveniently from dry-cells, from a single lead storage-cell, or from an air-cell battery. For dry-cell operation, a filament rheostat may be used together with a permanently installed voltmeter to insure the proper filament voltage. For operation from a 2-volt lead storage-cell, the '30 requires no filament resistor. Operation with an air-cell battery requires a fixed resistor in the filament circuit. This resistor should have a value such that with a new air-cell battery, the voltage applied across the filament terminals will not initially exceed 2.15 volts. *Series operation of the filaments of these tubes is not recommended.*

APPLICATION

As a **detector**, the '30 may be operated either with grid leak and condenser or with grid bias. The plate voltage for the former method should preferably not be more than 45 volts. A grid leak of from 1 to 5 megohms used with a grid condenser of 0.00025 μ f. is satisfactory. The grid return should be connected to the positive filament socket terminal. For grid bias detection, plate voltages up to the maximum value of 180 volts may be used. The corresponding grid bias should be adjusted so that the plate current is about 0.2 milliamperes when no signal is being received.

As an **amplifier**, the '30 is applicable to the audio- and the radio-frequency stages of a receiver. Plate voltages and the corresponding grid voltages should be determined from the CHARACTERISTICS and the curves in order to obtain optimum performance and freedom from distortion.

As an **oscillator**, this tube may be used at plate voltages not exceeding 45 volts.

THE RCA RADIOTRON MANUAL

AVERAGE PLATE CHARACTERISTICS

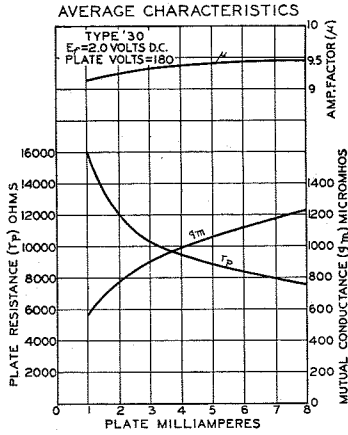
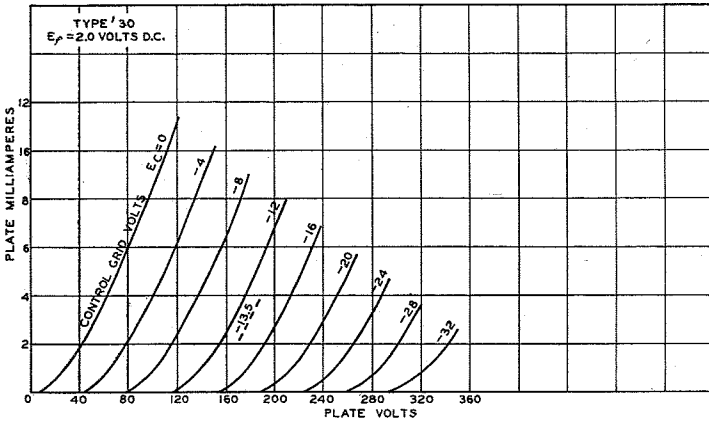

AVERAGE PLATE CHARACTERISTICS

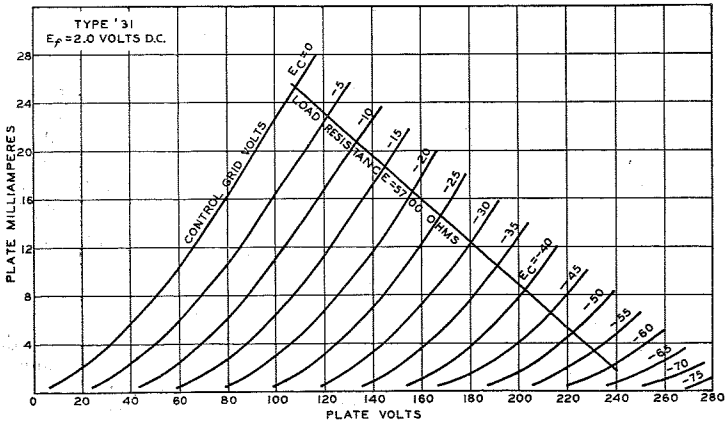

RCA Radiotron

RCA-231

POWER AMPLIFIER

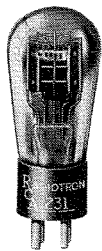

The '31 is a power amplifier tube of the three-electrode type. It has a coated filament which takes as little power as possible consistent with satisfactory operating performance. This feature makes the '31 particularly suitable in battery-operated radio receivers employing the '30, '32, and/or '34 where economy of filament current drain is important.

CHARACTERISTICS

FILAMENT VOLTAGE (D. C.)	2.0	Volts
FILAMENT CURRENT	0.130	Ampere
PLATE VOLTAGE	135	180 <i>max.</i> Volts
GRID VOLTAGE	-22.5	-30 Volts
PLATE CURRENT	8.0	12.3 Milliamperes
PLATE RESISTANCE	4100	3600 Ohms
AMPLIFICATION FACTOR	3.8	3.8
MUTUAL CONDUCTANCE	925	1050 Micromhos
LOAD RESISTANCE	7000	5700 Ohms
UNDISTORTED POWER OUTPUT	185	375 Milliwatts
GRID-PLATE CAPACITANCE		5.7 μ f.
GRID-FILAMENT CAPACITANCE		3.7 μ f.
PLATE-FILAMENT CAPACITANCE		2.2 μ f.
MAXIMUM OVERALL LENGTH		4 $\frac{1}{4}$ "
MAXIMUM DIAMETER		1 $\frac{9}{16}$ "
BULB (See page 42, Fig. 6)		S-12
BASE		Small 4-Pin

INSTALLATION

The base pins of the '31 fit the standard four-contact socket. The socket should be installed so that the tube will operate in a vertical position. Although the '31 is very free from microphonic disturbances, cushioning of its socket may be desirable. For socket connections, see page 39, Fig. 1.

The coated filament of the '31 may be operated conveniently from dry-cells, from a single lead storage-cell, or from an air-cell battery. For dry-cell operation, a filament rheostat may be used together with a permanently installed voltmeter to insure the proper filament voltage. For operation from a 2-volt lead storage-cell, the '31 requires no filament resistor. Operation with an air-cell battery requires a fixed resistor in the filament circuit. This resistor should have a value such that with a new air-cell battery, the voltage applied across the filament terminals will not initially exceed 2.15 volts. *Series operation of the filaments of these tubes is not recommended.*

APPLICATION

As a **power amplifier**, the '31 should be operated as shown under CHARACTERISTICS.

Grid voltage for the '31 may be obtained from a C-battery, or by use of the voltage drop in a resistor connected in the negative plate return lead. The latter method is known as the self-biasing method and is required where a grid resistor (maximum value 1 megohm) is used.

If more output is desired than can be obtained from a single '31, two '31's may be operated either in parallel or push-pull connection. Average plate characteristics (curves) are given on the preceding page.



RCA Radiotron

RCA-232

RADIO-FREQUENCY AMPLIFIER

The '32 is a screen grid tube recommended primarily for use as a radio-frequency amplifier. It contains a coated filament which takes as little power as possible consistent with satisfactory operating performance. This feature makes the '32 particularly suitable in battery-operated radio receivers employing the '34, '31, and/or '33 where economy of filament current drain is important.

CHARACTERISTICS

FILAMENT VOLTAGE (D. C.)	2.0	Volts
FILAMENT CURRENT	0.060	Ampere
PLATE VOLTAGE	135	Volts
SCREEN VOLTAGE	67.5	67.5 max. Volts
GRID VOLTAGE	-3	-3 Volts
PLATE CURRENT	1.7	1.7 Milliampere
SCREEN CURRENT (Maximum)	0.4	0.4 Milliampere
PLATE RESISTANCE	950000	1200000 Ohms
AMPLIFICATION FACTOR	610	780
MUTUAL CONDUCTANCE	640	650 Micromhos
EFFECTIVE GRID-PLATE CAPACITANCE	0.015 maximum	μf.
INPUT CAPACITANCE	6.0	μf.
OUTPUT CAPACITANCE	11.7	μf.
OVERALL LENGTH		4 ²⁵ / ₃₂ " to 5 ¹ / ₃₂ "
MAXIMUM DIAMETER		1 ¹³ / ₁₆ "
BULB (See page 42, Fig. 11)		S-14
CAP		Small Metal
BASE		Medium 4-Pin

INSTALLATION

The base pins of the '32 fit the standard four-contact socket. The socket should be installed so that the tube will operate in a vertical position. Although the '32 is very free from microphonic disturbances, cushioning of its socket may be found desirable. For socket connections, see page 39, Fig. 4.

The coated filament of the '32 may be operated conveniently from dry-cells, from a single lead storage-cell, or from an air-cell battery. For dry-cell operation, a filament rheostat should be used together with a permanently installed voltmeter to insure the proper filament voltage. For operation from a 2-volt lead storage-cell, the '32 requires no filament resistor. Operation with an air-cell battery requires a fixed resistor in the filament circuit. This resistor should have a value such that with a new air-cell battery, the voltage applied across the filament terminals will not initially exceed 2.15 volts. *Series operation of the filaments of these tubes is not recommended.*

The positive screen voltage may be obtained from a tap on the plate battery or a bleeder circuit across the supply battery in part or in full. Never attempt to obtain the screen voltage for the '32 by connecting the screen through a series resistor to a high voltage source. The results will not be satisfactory because of voltage drop variation produced by the different screen currents of individual tubes.

Volume control may be very satisfactorily accomplished by variation of the screen voltage between 0 and 67.5 volts. The variation must, however, be accomplished

(Continued on Page 43)

Socket Connections for RCA Radiotrons

These socket connection diagrams are to be used in conjunction with either the text, or the consolidated CHARACTERISTICS CHART. The correct socket connection for each tube is identified by a figure number which is given under INSTALLATION of each tube description and under Socket Connections of the CHARACTERISTICS CHART.

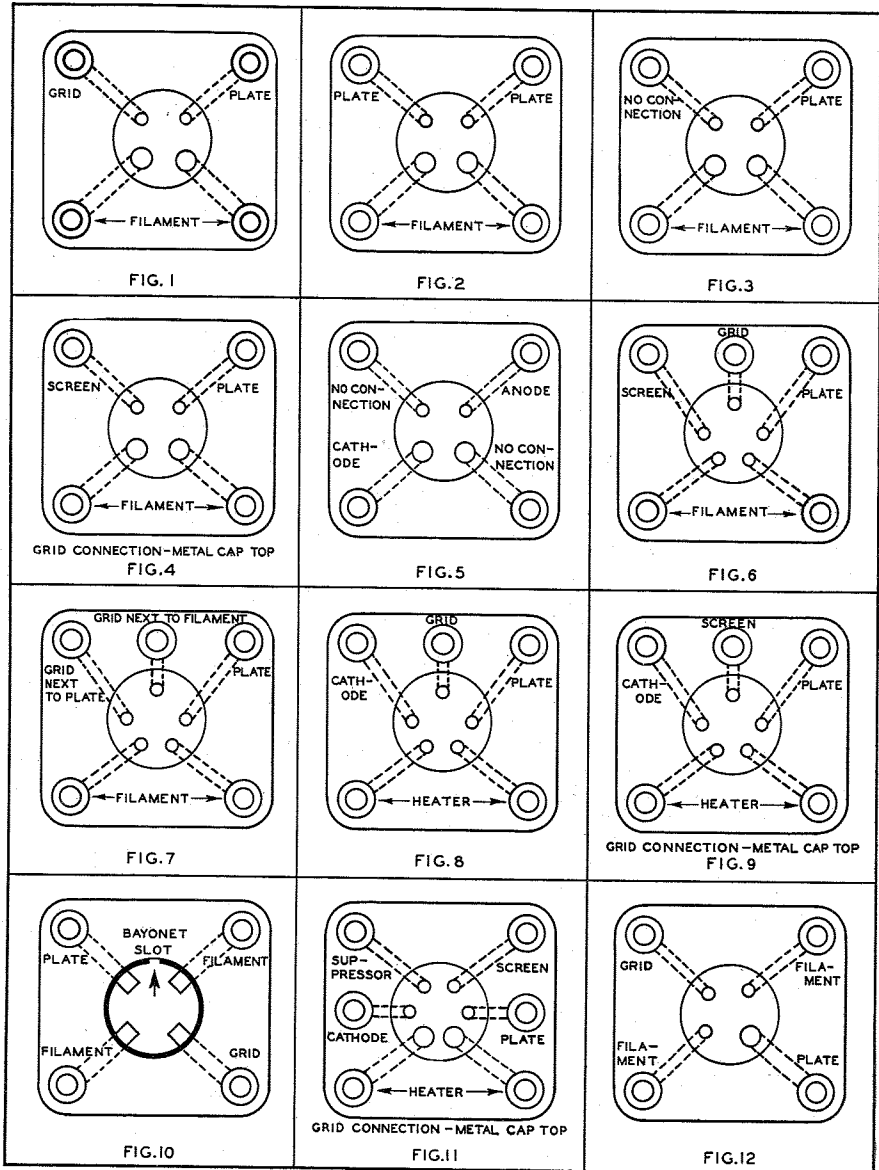

TOP VIEWS OF SOCKETS

RCA RADIOTRON CHARACTERISTICS CHART DETECTORS AND AMPLIFIERS

TYPE	PURPOSE	BASE	SOCKET CONNECTIONS SEE MANUAL PAGE 39	DIMENSIONS MAX. OVERALL		CATHODE TYPE	RATING			PLATE SUPPLY VOLTS	NEGATIVE GRID BIAS		SCREEN VOLTS ON FIL.	PLATE CURRENT MILLI-AMPS.	SCREEN CURRENT MILLI-AMPS.	A C PLATE RESISTANCE OHMS	MUTUAL INDUCTANCE MICRO-MHOS	VOLTAGE GAIN FACTOR	OHMS LOAD FOR STATED POWER OUTPUT	POWER OUTPUT MILLI-WATTS
				LENGTH	DIAM.		FILAMENT (OR HEATED) VOLTS	AMPLIFIER SUPPLY	AMPLIFIER		D C ON FIL.	A C ON FIL.								
UX -200-A	DETECTOR	MEDIUM 4-PIN	FIG. 1	4 1/8"	1 1/8"	FILAMENT	5.0	0.25	0	45	Grid Return to (-) Filament	2.5	3.0	30000	666	20	---	---	---	
UX -201-A	DETECTOR * AMPLIFIER	MEDIUM 4-PIN	FIG. 1	4 1/8"	1 1/8"	FILAMENT	5.0	0.25	0	135	4.5	11000	725	8.0	---	---	---	---	---	
W0 -11 WX -12	DETECTOR * AMPLIFIER	NO 4-PIN MEDIUM 4-PIN	FIG. 12 FIG. 1	4 1/8"	1 1/8"	FILAMENT	1.1	0.25	0	135	4.5	15000	440	6.6	---	---	---	---	---	
UX -112-A	DETECTOR * AMPLIFIER	MEDIUM 4-PIN	FIG. 1	4 1/8"	1 1/8"	FILAMENT	5.0	0.25	0	180	9.0	5800	1500	8.3	---	---	---	---	---	
UX -222	RADIO FREQ. AMPLIFIER	MEDIUM 4-PIN	FIG. 4	5 3/8"	1 1/8"	FILAMENT	3.3	0.132	0	135	67.5	67.5	1.5	45	---	---	---	---	---	
UY -224-A	BIASED AMPLIFIER	MEDIUM 4-PIN	FIG. 9	5 3/8"	1 1/8"	HEATER	2.5	1.75	A C	275	90	250	3.0	3.0	---	---	---	---	---	
UY -224-A	BIASED DETECTOR	MEDIUM 4-PIN	FIG. 9	5 3/8"	1 1/8"	HEATER	2.5	1.75	A C	275	90	275	5	20	---	---	---	---	---	
UX -226	AMPLIFIER	MEDIUM 4-PIN	FIG. 1	4 1/8"	1 1/8"	FILAMENT	1.5	1.05	A C	180	180	13.5	14.5	6.2	---	---	---	---	---	
UY -227	AMPLIFIER	MEDIUM 4-PIN	FIG. 8	4 1/8"	1 1/8"	HEATER	2.5	1.75	A C	275	180	13.5	13.5	5.0	---	---	---	---	---	
UY -227	BIASED * DETECTOR	MEDIUM 4-PIN	FIG. 8	4 1/8"	1 1/8"	HEATER	2.5	1.75	A C	275	250	21.0	21.0	5.2	---	---	---	---	---	
RCA-230	DETECTOR * AMPLIFIER	MEDIUM 4-PIN	FIG. 1	4 1/8"	1 1/8"	FILAMENT	2.0	0.06	0	180	135	9.0	13.5	3.1	---	---	---	---	---	
RCA-232	RADIO FREQ. AMPLIFIER	MEDIUM 4-PIN	FIG. 4	5 3/8"	1 1/8"	FILAMENT	2.0	0.06	0	180	67.5	6.0	6.0	1.7	---	---	---	---	---	
RCA-232	BIASED DETECTOR	MEDIUM 4-PIN	FIG. 4	5 3/8"	1 1/8"	FILAMENT	2.0	0.06	0	180	67.5	6.0	6.0	1.7	---	---	---	---	---	
RCA-234	SUPER-CONTROL R.F. AMPLIFIER	MEDIUM 4-PIN	FIG. 4	5 3/8"	1 1/8"	FILAMENT	2.0	0.06	0	180	67.5	3.0	3.0	2.7	---	---	---	---	---	
RCA-235	SUPER-CONTROL R.F. AMPLIFIER	MEDIUM 4-PIN	FIG. 9	5 3/8"	1 1/8"	HEATER	2.5	1.75	A C	275	180	1.5	1.5	2.8	---	---	---	---	---	
RCA-236	RADIO FREQ. AMPLIFIER	SMALL 5-PIN	FIG. 9	4 3/8"	1 1/8"	HEATER	6.3	0.3	0	180	90	13.5	13.5	3.0	---	---	---	---	---	
RCA-236	BIASED DETECTOR	SMALL 5-PIN	FIG. 9	4 3/8"	1 1/8"	HEATER	6.3	0.3	0	180	67.5	6.0	6.0	3.1	---	---	---	---	---	
RCA-237	AMPLIFIER	SMALL 5-PIN	FIG. 8	4 3/8"	1 1/8"	HEATER	6.3	0.3	0	180	135	9.0	9.0	4.3	---	---	---	---	---	
RCA-237	BIASED DETECTOR	SMALL 5-PIN	FIG. 8	4 3/8"	1 1/8"	HEATER	6.3	0.3	0	180	10.0	4.0	4.0	4.7	---	---	---	---	---	
RCA-239	SUPER-CONTROL R.F. AMPLIFIER	SMALL 5-PIN	FIG. 9	4 3/8"	1 1/8"	HEATER	6.3	0.3	0	180	135	13.5	13.5	2.8	---	---	---	---	---	
UX -240	VOLTAGE AMPLIFIER	MEDIUM 4-PIN	FIG. 1	4 1/8"	1 1/8"	FILAMENT	5.0	0.25	0	180	135	3.0	3.0	0.2	---	---	---	---	---	
RCA-56	AMPLIFIER	SMALL 5-PIN	FIG. 8	4 3/8"	1 1/8"	HEATER	2.5	1.0	A C	250	250	13.5	13.5	5.0	---	---	---	---	---	
RCA-56	BIASED * DETECTOR	SMALL 5-PIN	FIG. 8	4 3/8"	1 1/8"	HEATER	2.5	1.0	A C	250	20	20	20	1.0	---	---	---	---	---	
RCA-57	RADIO FREQ. AMPLIFIER	SMALL 5-PIN	FIG. 11	4 3/8"	1 1/8"	HEATER	2.5	1.0	A C	250	100	3.0	3.0	2.0	---	---	---	---	---	

RCA-57	BIASED SUPER-CONTROL BY AMPLIFIER	SMALL 6-PIN	FIG. 11	4 $\frac{1}{2}$ " ^W	1 $\frac{1}{2}$ " ^H	HEATER	2-5	1.0	A 6 $\frac{3}{4}$ " D C	250	100	275 $\frac{1}{2}$	6.0 approx.	100	Plate current to be adjusted to 0.1 milliamperes per mA signal.	
RCA-58	DIODE	SMALL 6-PIN	FIG. 11	4 $\frac{1}{2}$ " ^W	1 $\frac{1}{2}$ " ^H	HEATER	2-5	1.0	A 6 $\frac{3}{4}$ " D C	250	100	250	3.0	100	8.2	800000
UX-189	DIODE	SMALL 4-PIN	FIG. 10	3 $\frac{1}{2}$ " ^W	1 $\frac{1}{2}$ " ^H	FILAMENT	3-3	0.063	D C	50	—	50	4-5	—	2.5	15500
UX-189	DIODE	SMALL 4-PIN	FIG. 11	4 $\frac{1}{2}$ " ^W	1 $\frac{1}{2}$ " ^H	FILAMENT	3-3	0.063	D C	50	—	50	4-5	—	2.5	15500

*For Grid/leak Diode—plate volts 45; grid return to + filament or to cathode.
 †Applied through plate coupling resistor of 50000 ohms.
 ‡Applied through plate coupling resistor of 250000 ohms or 500 henry choke shunted by 0.25 megohm resistor.
 §Seven current not over 24 of plate current.

POWER AMPLIFIERS

RCA-210	POWER AMPLIFIER	MEDIUM 4-PIN	FIG. 1	5 $\frac{1}{2}$ " ^W	2 $\frac{1}{2}$ " ^H	FILAMENT	7-5	1-2.5	A 6 $\frac{3}{4}$ " D C	425	—	250	18.0	—	6000	1330	8.0	13000	
UX-112-A	POWER AMPLIFIER	MEDIUM 4-PIN	FIG. 1	4 $\frac{1}{2}$ " ^W	1 $\frac{1}{2}$ " ^H	FILAMENT	5-0	0.25	D C	180	—	180	35.0	—	5300	15500	8.0	11000	
UX-120	POWER AMPLIFIER	SMALL 4-PIN	FIG. 1	4 $\frac{1}{2}$ " ^W	1 $\frac{1}{2}$ " ^H	FILAMENT	3-3	0.132	D C	135	—	135	9.0	—	5300	1600	8.5	8700	
RCA-231	POWER AMPLIFIER	SMALL 5-PIN	FIG. 6	4 $\frac{1}{2}$ " ^W	1 $\frac{1}{2}$ " ^H	FILAMENT	2-0	0.130	D C	180	—	180	16.5	—	5300	1700	8.5	10800	
RCA-233	POWER AMPLIFIER	MEDIUM 5-PIN	FIG. 6	4 $\frac{1}{2}$ " ^W	1 $\frac{1}{2}$ " ^H	FILAMENT	2-0	0.26	D C	135	135	135	13.5	—	6300	925	3.3	6500	
RCA-238	POWER AMPLIFIER	SMALL 5-PIN	FIG. 9	4 $\frac{1}{2}$ " ^W	1 $\frac{1}{2}$ " ^H	HEATER	6-3	0.3	D C	135	135	135	34.5	—	4100	925	3.3	6500	
UX-245	POWER AMPLIFIER	MEDIUM 4-PIN	FIG. 1	5 $\frac{1}{2}$ " ^W	2 $\frac{1}{2}$ " ^H	FILAMENT	2-5	1-5	A 6 $\frac{3}{4}$ " D C	275	—	250	48.5	—	1900	1850	3.5	3500	
RCA-46	POWER AMPLIFIER CLASS A 1	MEDIUM 5-PIN	FIG. 7	5 $\frac{1}{2}$ " ^W	2 $\frac{1}{2}$ " ^H	FILAMENT	2-5	1-7.5	A 6 $\frac{3}{4}$ " D C	250	—	250	31.5	—	2380	2350	5-6	6400	
RCA-46	POWER AMPLIFIER CLASS B	MEDIUM 5-PIN	FIG. 7	5 $\frac{1}{2}$ " ^W	2 $\frac{1}{2}$ " ^H	FILAMENT	2-5	1-7.5	A 6 $\frac{3}{4}$ " D C	400	—	400	0	—	For these characteristics, refer to text on 46 in Manual	1300	16000		
RCA-247	POWER AMPLIFIER	MEDIUM 5-PIN	FIG. 6	5 $\frac{1}{2}$ " ^W	2 $\frac{1}{2}$ " ^H	FILAMENT	2-5	1-7.5	A 6 $\frac{3}{4}$ " D C	250	250	250	15.0	250	6.0	60000	2500	150	7000
UX-250	POWER AMPLIFIER	MEDIUM 4-PIN	FIG. 1	6 $\frac{1}{2}$ " ^W	2 $\frac{1}{2}$ " ^H	FILAMENT	7-5	1-2.5	A 6 $\frac{3}{4}$ " D C	450	—	450	80.0	—	45.0	1500	2000	3-8	4100
UX-171-A	POWER AMPLIFIER	MEDIUM 4-PIN	FIG. 1	4 $\frac{1}{2}$ " ^W	1 $\frac{1}{2}$ " ^H	FILAMENT	5-0	0.25	A 6 $\frac{3}{4}$ " D C	180	—	180	39.5	—	55.0	1800	2100	3-8	3670

•Two grids tied together.

•Grid next to plate tied to plate.

RECTIFIERS

UX-280	FULL-WAVE RECTIFIER	MEDIUM 4-PIN	FIG. 2	5 $\frac{1}{2}$ " ^W	2 $\frac{1}{2}$ " ^H	FILAMENT	5-0	2.0	A C	350	400	550	350	400	550	For d-c output voltage, refer to curves in Manual.
UX-281	HALF-WAVE RECTIFIER	MEDIUM 4-PIN	FIG. 3	6 $\frac{1}{2}$ " ^W	2 $\frac{1}{2}$ " ^H	FILAMENT	7-5	1-2.5	A C	125	110	135	125	110	135	For d-c output voltage, refer to curves in Manual.
RCA-82	FULL-WAVE RECTIFIER	MEDIUM 4-PIN	FIG. 2	4 $\frac{1}{2}$ " ^W	1 $\frac{1}{2}$ " ^H	FILAMENT	2-5	3.0	A C	750	750	750	750	750	750	For d-c output voltage delivered to filter of typical rectifier circuit refer to curves in Manual.
RCA-866	MEDIUM-WAVE RECTIFIER	MEDIUM 4-PIN	—	6 $\frac{3}{8}$ " ^W	2 $\frac{1}{2}$ " ^H	FILAMENT	2-5	5-0	A C	7500	7500	7500	7500	7500	7500	For additional information refer to Technical Bulletin.

REGULATORS

UX-874	VOLTAGE REGULATOR	MEDIUM 4-PIN	—	5 $\frac{1}{2}$ " ^W	2 $\frac{1}{2}$ " ^H	—	—	—	—	—	—	—	—	—	—	Operating Voltage..... 90 Volts D C
UX-876	REGULATOR (BALLAST TUBE)	NOBUL	—	8"	2 $\frac{1}{2}$ " ^H	—	—	—	—	—	—	—	—	—	—	Starting Voltage..... 125 Volts D C
UX-886	CURRENT REGULATOR (BALLAST TUBE)	NOBUL	—	8"	2 $\frac{1}{2}$ " ^H	—	—	—	—	—	—	—	—	—	—	Operating Current..... 1.7 Amperes
																Operating Current..... 2.05 Amperes
																Voltage Range..... 40-80 Volts
																Voltage Range..... 40-80 Volts

For other RCA Radiotrons of special interest to the radio amateur, refer to inside of back cover.

Maximum Overall Dimensions of RCA Radiotrons

This chart of overall tube dimensions is to be used in conjunction with the text. The correct bulb reference number for each tube is given under its CHARACTERISTICS.

The prefix letters of the bulb designation indicate the bulb shape; as S for "straight side," T for "tubular," and ST for a combination of tubular and straight side or "dome type." The suffix numbers of the bulb designations indicate the nominal maximum diameter of the bulb in eighths of inches, i.e., the diameter of the S-12 is 12 eighths, or $1\frac{1}{2}$ ".

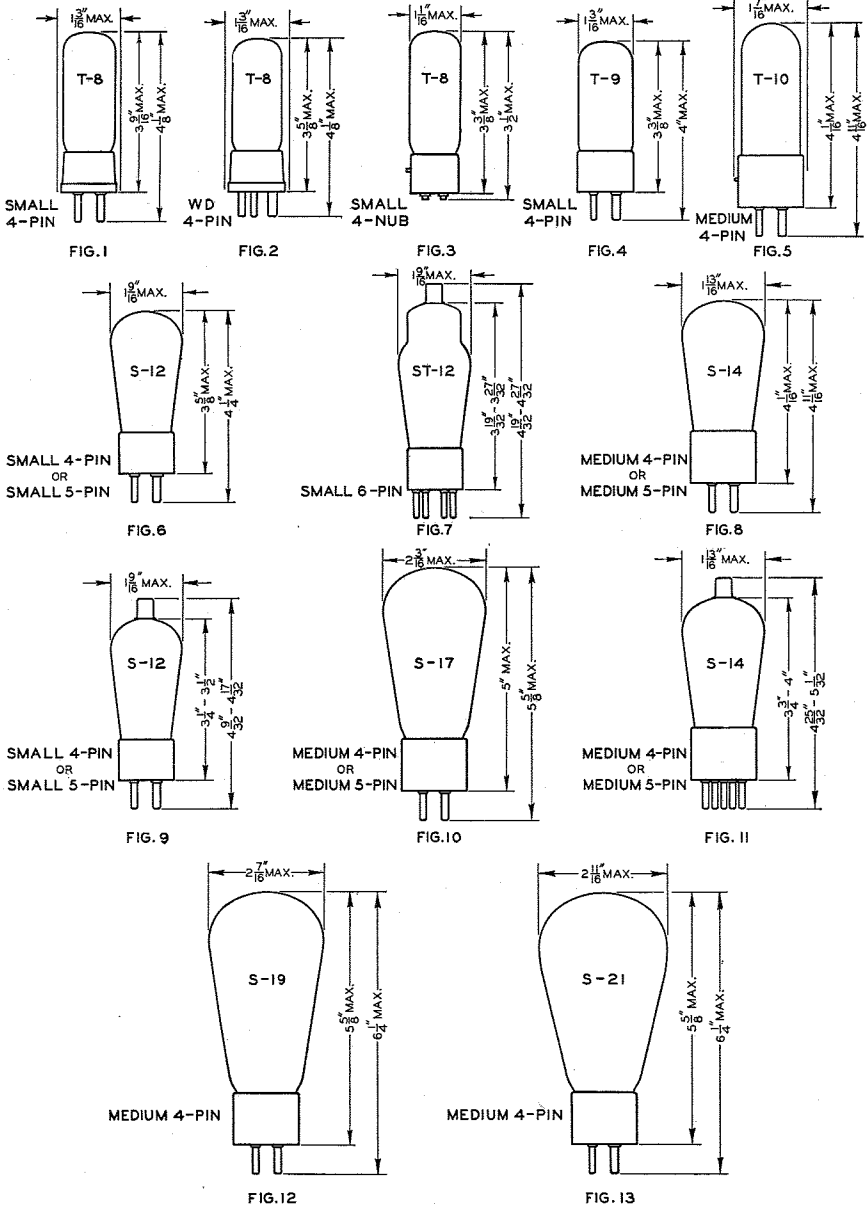

THE RCA RADIOTRON MANUAL

(Continued from Page 38)

by a potentiometer shunted across the screen voltage supply and not by a high-resistance rheostat.

Complete **shielding** of all stages is recommended if maximum gain per stage is to be obtained.

APPLICATION

As a **radio-frequency amplifier**, the '32 is operated as shown under CHARACTERISTICS. Neither the plate voltage nor the screen voltage is critical. In general, properly designed radio-frequency transformers are preferable to interstage coupling impedances, especially in cases where a high impedance B-supply may cause oscillation below radio frequencies.

As a **detector**, the '32 may be operated either with grid leak and condenser or with grid bias. For grid bias detection, suitable operating conditions are: Plate supply voltage, 135 volts applied through a plate coupling resistance of 100000 ohms or an equivalent impedance; positive screen voltage, 67.5 volts; and a negative grid bias (approximately 6 volts) so adjusted that a plate current of 0.2 milliamperes is obtained with no a-c input signal. For grid leak and condenser detection, suitable operating conditions are: Plate supply voltage, 135 volts applied through a plate coupling resistor of 250000 ohms; a positive screen voltage up to 45 volts; a grid condenser of 0.00025 μ f.; and a grid leak of 1 to 5 megohms.

In designing circuits to use the '32 as a detector, it is desirable to work from the detector stage directly into the power output stage.

As an **audio-frequency amplifier** in resistance coupled circuits, the '32 may be operated under the following conditions: Plate supply voltage, 180 volts applied through a plate coupling resistor of 100000 to 250000 ohms (or a 500 henry choke shunted by a 0.25 megohm resistor); plate current, 0.25 milliamperes (approximate); grid voltage, -1 volt; and a grid resistor, 0.25 to 2.0 megohms.

AVERAGE PLATE CHARACTERISTICS

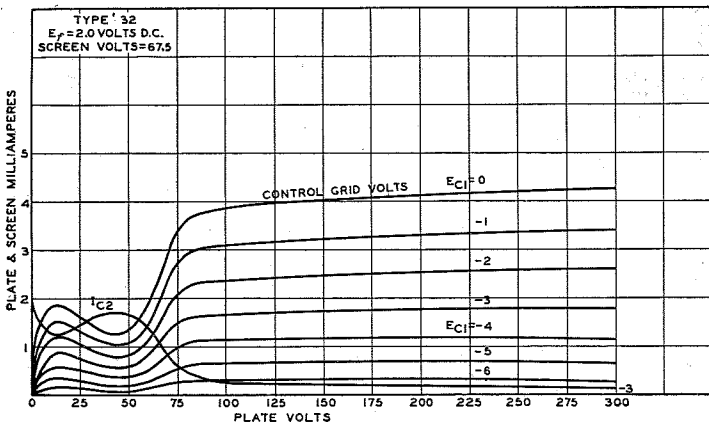

RCA Radiotron

RCA-233

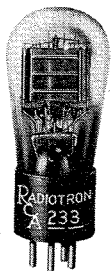

POWER AMPLIFIER PENTODE

The '33 is a power amplifier pentode for use in the output stage of battery-operated receivers. The low filament current required by the '33 makes this tube particularly applicable for use in combination with the '30, '32, and/or '34 in radio sets where economy of battery consumption is important.

The '33 is capable of producing greater power output than three-electrode power amplifiers of the same plate current drain. Furthermore, this tube has the design feature of greater amplification than is possible in a three-electrode amplifier without serious sacrifice in power output.

The power-handling ability of the '33 is made possible by the addition of both a suppressor and a screen between the grid and plate. The suppressor is placed next to the plate and is connected inside the tube to the filament. This design practically eliminates the secondary emission effects which limit the power output from four-electrode screen grid tubes. See page 5.

CHARACTERISTICS

FILAMENT VOLTAGE (D. C.)	2.0	Volts
FILAMENT CURRENT	0.260	Ampere
PLATE VOLTAGE	135 max.	Volts
SCREEN VOLTAGE	135 max.	Volts
GRID VOLTAGE	-13.5	Volts
PLATE CURRENT	14.5	Milliamperes
SCREEN CURRENT	3	Milliamperes
PLATE RESISTANCE	50000	Ohms
AMPLIFICATION FACTOR	70	
MUTUAL CONDUCTANCE	1450	Micromhos
LOAD RESISTANCE	7000	Ohms
POWER OUTPUT	700	Milliwatts
EFFECTIVE GRID-PLATE CAPACITANCE	0.9	μ mf.
INPUT CAPACITANCE	8.9	μ mf.
OUTPUT CAPACITANCE	11.1	μ mf.
MAXIMUM OVERALL LENGTH		4 11/16"
MAXIMUM DIAMETER		1 13/16"
BULB (See page 42, Fig. 8)		S-14
BASE		Medium 5-Pin

INSTALLATION

The base pins of the '33 fit the standard five-contact socket. The socket should be installed so that the tube will operate in a vertical position. In some cases, cushioning of the socket may be found desirable. For socket connections, see page 39, Fig. 6.

For filament operation, refer to INSTALLATION for type '32.

APPLICATION

For the power amplifier stage of radio receivers, the '33 is recommended either singly or in push-pull combination. More than one audio stage preceding the '33 is undesirable because of the possibility of microphonic disturbances resulting from the high level of amplification.

THE RCA RADIOTRON MANUAL

If a single '33 is operated self-biased, the self-biasing resistor should be approximately 770 ohms. This resistor should be shunted by a condenser of 4 to 20 μf . to avoid degeneration effects at low audio frequencies. The use of two '33's in push-pull eliminates the necessity of by-passing the resistor. The self-biasing resistor required for the push-pull stage is approximately 385 ohms.

Any conventional type of **input coupling** may be used, provided that the resistance added to the circuit by this device is not too high. Transformer or impedance coupling devices are preferable. When the input circuit of the '33 is resistance-coupled to the preceding stage, self-bias should be employed. The grid resistor should not exceed a value of more than 1.0 megohm under self-bias conditions; without self-bias, maximum value is 0.5 megohm.

An **output transformer** should be used to couple this tube to the winding of the reproducing unit. The optimum load resistance for the output device is 7000 ohms. For best results, the impedance in the plate circuit of the '33 should be as uniform as possible over the entire audio-frequency range.

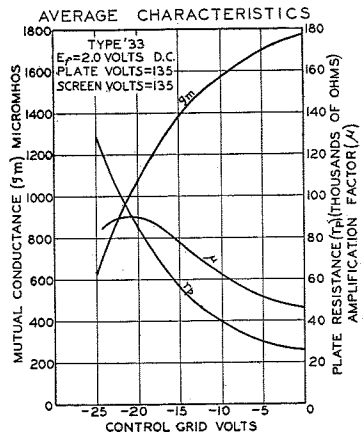
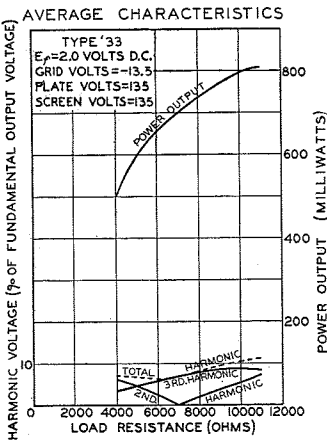
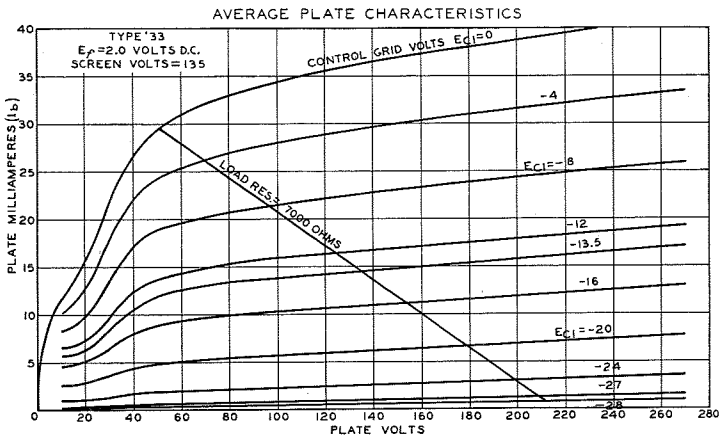

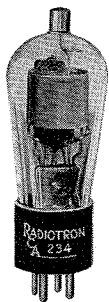

RCA Radiotron

RCA-234

SUPER-CONTROL R-F AMPLIFIER PENTODE

The '34 is a super-control pentode recommended for use primarily as a radio-frequency amplifier and intermediate-frequency amplifier in battery-operated receivers employing the '30, '31, '32, and/or '33 where economy of filament current drain is important.

The '34 is very effective in reducing cross-modulation and modulation-distortion over the usual range of signal voltages without the use of antenna potentiometers or auxiliary volume control switches. (See Super-Control amplifier page 15.) This super-control characteristic makes the tube uniquely adaptable to the r-f and i-f stages of receivers employing automatic volume control.

The use of a **suppressor** is an important feature of the '34. In comparison with the usual type of screen grid tube operated under similar conditions, the '34 has a much higher plate resistance and a considerably increased range of voltage swing. Furthermore, a high value of mutual conductance is maintained.

The suppressor is connected inside the tube to the filament. During operation of the tube, the suppressor eliminates the secondary emission effects which limit the voltage swing permissible in the usual screen grid tube at low plate voltage, that is, at a plate voltage approximately equal to the screen voltage. The suppressor in the '34, therefore, makes possible efficient operation of this tube at a relatively low plate voltage. This may be greater than, equal to, or slightly less than the recommended screen voltage.

CHARACTERISTICS

FILAMENT VOLTAGE (D. C.)	2.0	Volts
FILAMENT CURRENT	0.060	Ampere
PLATE VOLTAGE	67.5** 135	180 max. Volts
SCREEN VOLTAGE (Max.*)	67.5 67.5	67.5 Volts
GRID VOLTAGE, Variable (Minimum)	-3 -3	-3 Volts
PLATE CURRENT	2.7 2.8	2.8 Milliamperes
SCREEN CURRENT	1.1 1.0	1.0 Milliamperes
PLATE RESISTANCE	400000 600000 1000000	Ohms
AMPLIFICATION FACTOR	224 360 620	
MUTUAL CONDUCTANCE	560 600 620	Micromhos
MUTUAL CONDUCTANCE, at -22.5 volts bias 15	15 15	15 Micromhos
EFFECTIVE GRID-PLATE CAPACITANCE	0.020 maximum	μf.
INPUT CAPACITANCE	6.4	μf.
OUTPUT CAPACITANCE	12.8	μf.
OVERALL LENGTH		4 ²⁵ / ₃₂ " to 5 ¹ / ₃₂ "
MAXIMUM DIAMETER		1 ³ / ₁₆ "
BULB (See page 42, Fig. 11)		S-14
CAP		Small Metal
BASE		Medium 4-Pin

* Under conditions of maximum plate current.

** Recommended values for use in portable receivers.

INSTALLATION

The base pins of the '34 fit the standard four-contact socket. Although this tube is quite free from microphonic disturbances, cushioning of its socket may sometimes be desirable. For socket connections, see page 39, Fig. 4.

For **filament** operation, refer to INSTALLATION for type '32.

THE RCA RADIOTRON MANUAL

The **screen voltage** may be obtained from a tap on the B-supply battery or from a bleeder circuit across the battery, as a whole or in part. Due to the screen current characteristics of the '34, a resistor in series with the B-supply may be employed, if desired, for obtaining the screen voltage, providing the maximum voltage between screen and filament does not exceed 100 volts under conditions of reduced plate current.

Stage **shielding** enclosing all the components of each stage is, in general, necessary for multi-stage amplifier circuits.

APPLICATION

As an **r-f or i-f amplifier**, the '34 is applicable in receivers designed for it. Plate, screen, and minimum grid voltages are given under CHARACTERISTICS for a number of operating conditions.

Volume control of the receiver is accomplished effectively by variation of the negative voltage applied to the grid. In order to obtain adequate volume control, an available grid bias voltage of approximately -22.5 volts will be required. The exact value will depend upon the circuit design and operating conditions. This voltage may be obtained from a potentiometer, a bleeder circuit, or a separate source, depending on receiver requirements.

Owing to the fact that the super-control feature of the '34 requires a comparatively large grid bias change, the screen and plate voltage may vary considerably for various volume settings depending on receiver design. It is recommended therefore, that design features be incorporated in the receiver so that the screen voltage will not exceed 67.5 volts under conditions of minimum grid bias and maximum plate current. With a design arrangement of this kind, the screen voltage at decreased values of plate current may reach a value higher than 67.5 volts but should not exceed 100 volts. It should be recognized that under the condition of screen voltage above 67.5 volts at low plate current, an increase in the grid bias voltage supply must be provided for adequate volume control.

As the **first detector** in superheterodyne circuits, the '34 may be utilized to advantage. In such service, the grid bias may or may not be made variable. With variable bias in the first detector, the peak oscillator voltage should be preferably about one volt less than the lowest operating grid bias. This practice will eliminate the possibility of cross-modulation caused by the first detector drawing grid current. Without variable bias on the first detector, the oscillator peak voltage should be considerably less than the grid bias to prevent grid current on very strong signal swings. It should be noted that by varying the grid bias on the first detector in conjunction with that on the radio-frequency and/or the intermediate-frequency stages, additional control of volume may be accomplished.

AVERAGE PLATE CHARACTERISTICS

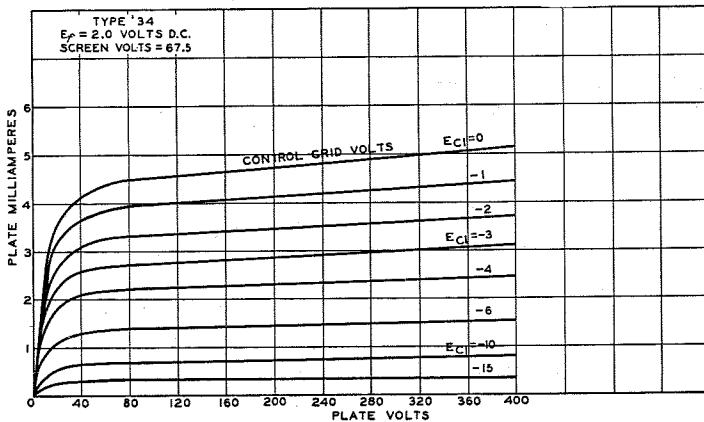



RCA Radiotron

RCA-235

SUPER-CONTROL RADIO-FREQUENCY AMPLIFIER

The '35 is a super-control screen grid amplifier tube containing a 2.5 volt heater-cathode of the equipotential type. It is recommended as a radio-frequency amplifier and an intermediate-frequency amplifier in a-c receivers. The '35 is very effective in reducing cross-modulation and modulation-distortion over the entire range of received signals. Its design is such as to permit easy control of a large range of signal voltages without the use of local-distance switches or antenna potentiometers. This super-control feature makes the tube adaptable to circuits incorporating automatic volume control. See page 15 for Super-Control feature.

CHARACTERISTICS

HEATER VOLTAGE (A. C. or D. C.)	2.5	Volts		
HEATER CURRENT	1.75	Amperes		
PLATE VOLTAGE*	180	250	Volts	
SCREEN VOLTAGE	75	90 max.	Volts	
GRID VOLTAGE, Variable (Minimum)	-1.5	-3	Volts	
PLATE CURRENT	5.8	6.5	Milliamperes	
SCREEN CURRENT (Maximum)	2.5	2.5	Milliamperes	
PLATE RESISTANCE	350000	350000	Ohms	
AMPLIFICATION FACTOR	385	370		
MUTUAL CONDUCTANCE	1100	1050	Micromhos	
MUTUAL CONDUCTANCE	{ At -40 volts bias	5	15	Micromhos
	{ At -50 volts bias	—	1 min.	Micromho
EFFECTIVE GRID-PLATE CAPACITANCE		0.010 maximum	μmf.	
INPUT CAPACITANCE		5	μmf.	
OUTPUT CAPACITANCE		10	μmf.	
OVERALL LENGTH		4 ²⁵ / ₃₂ "	to 5 ¹ / ₃₂ "	
MAXIMUM DIAMETER			1 ¹³ / ₁₆ "	
BULB (See page 42, Fig. 11)			S-14	
CAP			Small Metal	
BASE			Medium 5-Pin	

* Maximum plate voltage = 275 volts.

INSTALLATION

The base pins of the '35 fit the standard five-contact socket. The socket may be mounted to hold the tube in any position. For socket connections, see page 39, Fig. 9.

The heater of the '35 is intended for operation from a 2.5 volt winding of the power transformer. The voltage applied to the heater terminals should be the rated value of 2.5 volts under operating conditions and with average line voltage.

The cathode connection to the heater should be made (1) to the movable arm of a potentiometer connected across the heater winding of the power transformer, or (2) to a mid-tapped resistor across the heater winding, or (3) to the mid-point of the heater winding itself.

The positive screen voltage for the '35 may be obtained from a fixed or variable tap on a voltage divider across the supply voltage or a portion of the supply.

Complete shielding for all stages of the circuit is necessary if maximum gain and the volume-control range capabilities of this tube are to be realized.

THE RCA RADIOTRON MANUAL

APPLICATION

As a radio-frequency and intermediate-frequency amplifier, the '35 should be operated as shown under CHARACTERISTICS. In general, properly designed radio-frequency transformers are preferable to interstage coupling impedances, especially in cases where a high impedance B-supply may cause oscillation below radio frequencies.

Volume control of receivers designed for the '35 may be accomplished by variation of the negative grid bias of this tube. In order to utilize the full volume-control range of the '35, an available grid bias voltage of approximately 50 volts will be required, depending upon the circuit design and operating conditions. This voltage should preferably be obtained from a potentiometer or bleeder circuit. If, however, the receiver is designed so that the required volume control can be obtained without exceeding 45 volts, the cathode-resistor method of obtaining the grid-bias control is permissible.

As a detector working directly into an audio-frequency amplifier, the '35 is not ordinarily suited. However, this tube does have a very useful application as a first detector in superheterodyne circuits. Suitable operating voltages for such service are: Plate voltage, 250 volts; screen voltage, 90 volts; and grid bias, -7 volts with a 6-volt peak swing from the oscillator. By varying the grid bias on the first detector in conjunction with that on the radio-frequency and/or the intermediate-frequency stages, additional control of volume may be accomplished.

As an audio-frequency amplifier, the '35 may be used in a single stage, resistance-coupled circuit when it is followed by not more than one amplifier stage. Additional stages of amplification are not recommended because of the possibility of noise and microphonic disturbances resulting from the high level of amplification. Suitable operating voltages for such service are: Plate supply voltage, 180 to 250 volts, applied through a load resistor of 100000 to 200000 ohms; screen voltage 25 volts; grid bias, -1 volt. In general, the higher value of load resistor will permit increased amplification but will give poorer fidelity. The higher plate supply voltages allow increased signal swing without distortion but are not required where only small signals are to be amplified. In resistance-coupled circuits employing the '35, the grid resistor should have a value not exceeding 1.0 megohm.

AVERAGE PLATE CHARACTERISTICS

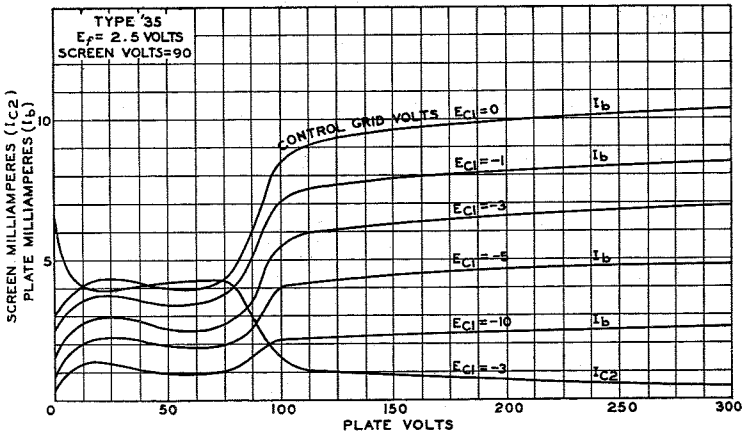

THE RCA RADIOTRON MANUAL

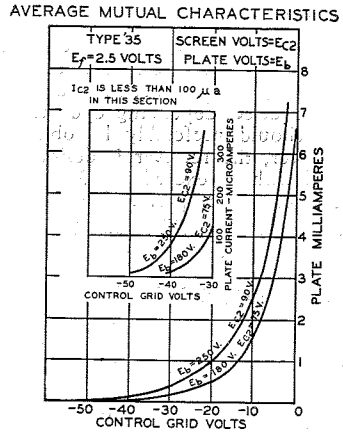
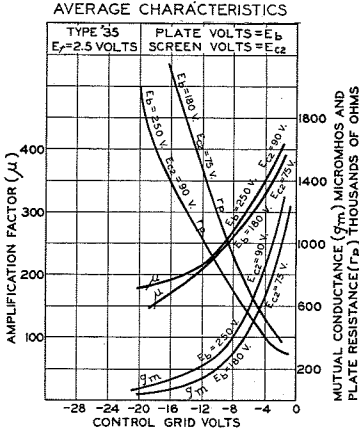

TYPICAL SUPERHETERODYNE RECEIVER FOR A-C OPERATION

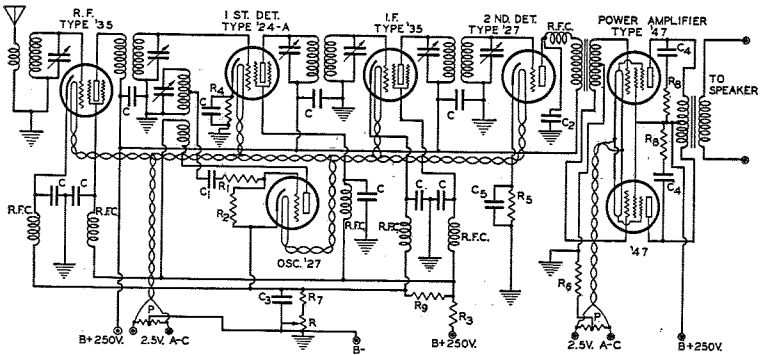

- C = R-F BY-PASS CONDENSER (0.1 μ f.)
- C₁ = OSC. GRID CONDENSER (0.00075 μ f.)
- C₂ = R-F BY-PASS CONDENSER (0.00025 μ f.)
- C₃ = R-F BY-PASS CONDENSER (0.5 μ f.)
- C₄ = CONDENSER (0.3 μ f. APPROX.)
- R = VOLUME CONTROL POTENTIOMETER (8 000 OHMS)
- R₁ = RESISTOR (6 000 OHMS)
- R₂ = OSCILLATOR GRID LEAK (40 000 OHMS)

- R₃ = RESISTOR (14 000 OHMS)
- R₄ = SELF-BIASING RESISTOR (1 500 OHMS)
- R₅ = SELF-BIASING RESISTOR (50 000 OHMS)
- R₆ = SELF-BIASING RESISTOR (225 OHMS)
- R₇ = PARTIAL SELF-BIAS RESISTOR (150 OHMS)
- R₈ = RESISTOR (10 000 OHMS APPROX.)
- R₉ = RESISTOR (8 000 OHMS)
- P = POTENTIOMETER (20 OHMS)
- C₅ = A-F BY-PASS CONDENSER (2-4 μ f.)

Optional power amplifier using '45's shown on page 61.

RCA Radiotron

RCA-236

RADIO-FREQUENCY AMPLIFIER



The '36 is a screen grid radio-frequency amplifier and detector for use in automobile receivers or sets operated from d-c power lines. It contains a heater-cathode which is designed for d-c operation. Its design permits uniform tube operation over a comparatively wide range of heater voltages without appreciably affecting either the performance or serviceability of the tube. This feature, together with that of general freedom from microphonic and battery circuit disturbances, makes the '36 well suited to mobile service and other applications where complete d-c operation is desirable.

CHARACTERISTICS

HEATER VOLTAGE (D. C.)		6.3	Volts
HEATER CURRENT		0.3	Ampere
PLATE VOLTAGE	90* 135	180 max.	Volts
SCREEN VOLTAGE	55 67.5	90 max.	Volts
GRID VOLTAGE	-1.5 -1.5	-3	Volts
PLATE CURRENT	1.8 3	3.1	Milliamperes
SCREEN CURRENT		Not over 1/3 of plate current	
PLATE RESISTANCE	250000 300000 350000		Ohms
AMPLIFICATION FACTOR	215 315 370		
MUTUAL CONDUCTANCE	850 1050 1050		Micromhos
EFFECTIVE GRID-PLATE CAPACITANCE		0.01 maximum	μf.
INPUT CAPACITANCE		3.7	μf.
OUTPUT CAPACITANCE		9.2	μf.
OVERALL LENGTH		4 ⁹ / ₃₂ " to 4 ¹⁷ / ₃₂ "	
MAXIMUM DIAMETER		1 ⁹ / ₁₆ "	
BULB (See page 42, Fig. 9)		S-12	
CAP		Small Metal	
BASE		Small 5-Pin	

* Particularly applicable to receivers designed for operation from 110-volt d.c. power line.

INSTALLATION

The base pins of the '36 fit the standard five-contact socket which may be mounted to hold the tubes in any position. For socket connections, see page 39, Fig. 9.

The heater of the '36 is designed to operate satisfactorily from a 6-volt automobile storage battery without a rheostat or fixed resistor, despite the voltage fluctuations during the charge and discharge periods. These variations in the applied heater voltage do not seriously affect the performance or serviceability of this tube. The heater may be operated in series with the heaters of the '37, '38 or '39. This feature is especially desirable in receivers designed to operate from d-c house mains. Regardless of the number of heaters connected in series, the current in the heater circuit should be adjusted to 0.3 ampere for the normal supply voltage.

The cathode circuit in most d-c receivers is usually tied in either directly or through biasing resistors to the negative side of the heater circuit. The voltage difference thus introduced between heater and cathode should be kept as much as possible below the recommended maximum of 45 volts.

The positive screen voltage for the '36 may be obtained from a section of the B-battery, or from a fixed or variable tap on a voltage divider connected across the

THE RCA RADIOTRON MANUAL

supply voltage, or a portion of the supply. The impedance between the screen and cathode should be kept as low as possible by means of suitable by-pass condensers.

Complete **shielding** of all stages of the circuit is necessary if maximum gain per stage is to be obtained.

APPLICATION

As a **radio-frequency amplifier**, the '36 should be operated as shown under CHARACTERISTICS. Neither the plate nor the screen voltage is critical. In general, properly designed radio-frequency transformers are preferable to interstage coupling impedances, especially in cases where a high impedance B-supply may cause oscillation below radio frequencies.

As a **detector**, the '36 may be operated either with grid leak and condenser or with grid bias. For grid bias detection, suitable operating conditions are: Plate supply voltage, 135 volts applied through a plate coupling resistor of 250000 ohms; positive screen voltage, 67.5 volts; and negative grid bias, 6 volts (approx.), so adjusted that a plate current of 0.1 milliamperere is obtained with no a-c input signal. When grid leak and condenser detection is employed, a plate voltage of 45 volts applied through a plate coupling resistor of 250000 ohms together with a positive screen voltage up to 45 volts will be satisfactory. A grid leak of 2 to 5 megohms and a grid condenser of 0.00025 μf . will be suitable.

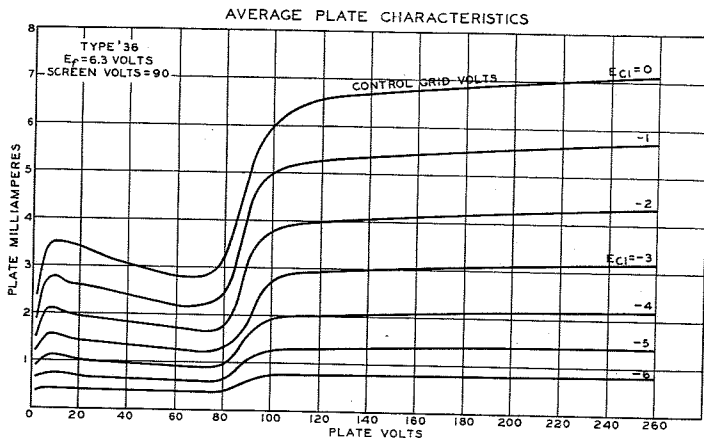

RCA Radiotron

RCA-237

DETECTOR, AMPLIFIER

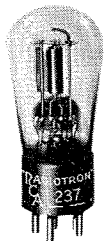

The '37 is a three-electrode general purpose tube for use in automobile receivers and in sets operated from d-c power lines. It contains a heater-cathode which is designed for d-c operation. This feature together with that of general freedom from microphonic and battery circuit disturbances makes the '37 well suited to mobile service and other applications where complete d-c operation is desirable.

CHARACTERISTICS

HEATER VOLTAGE (D. C.)	6.3	Volts
HEATER CURRENT	0.3	Ampere
PLATE VOLTAGE	90 135 180 max.	Volts
GRID VOLTAGE	-6 -9 -13.5	Volts
PLATE CURRENT	2.5 4.1 4.3	Milliamperes
PLATE RESISTANCE	11500 10000 10000	Ohms
AMPLIFICATION FACTOR	9.2 9.2 9	
MUTUAL CONDUCTANCE	800 925 900	Micromhos
GRID-PLATE CAPACITANCE	2.0	μ mf.
GRID-CATHODE CAPACITANCE	3.5	μ mf.
PLATE-CATHODE CAPACITANCE	2.2	μ mf.
MAXIMUM OVERALL LENGTH		4 $\frac{1}{4}$ "
MAXIMUM DIAMETER		1 $\frac{9}{16}$ "
BULB (See page 42, Fig. 6)		S-12
BASE		Small 5-Pin

INSTALLATION

The base pins of the '37 fit the standard five-contact socket. The socket may be mounted to hold the tube in any position. For socket connections, see page 39, Fig. 8.

The **heater** of the '37 is designed to operate satisfactorily from a 6-volt automobile storage battery without a rheostat or fixed resistor despite the voltage fluctuations during the charge and discharge periods. These variations in the applied heater voltage do not seriously affect the performance or serviceability of this tube. The heater may be operated in series with the heaters of the '36, '38 or '39. This feature is especially desirable in receivers designed to operate from d-c house mains. Regardless of the number of heaters connected in series, the current in the heater circuit should be adjusted to 0.3 ampere for the normal supply voltage.

The **cathode** circuit in most d-c receivers is usually tied in either directly or through biasing resistors to the negative side of the heater circuit. The voltage difference thus introduced between heater and cathode should be kept as much as possible below the recommended maximum of 45 volts.

APPLICATION

As a **detector**, the '37 may be operated with either grid leak and condenser or with grid bias. The recommended plate voltage for the grid leak and condenser method is 45 volts. A grid leak of from 1.0 to 5.0 megohms used with a grid condenser of 0.00025 μ f. is suitable.

For grid bias detection a plate voltage of 135 volts together with a negative grid bias of approximately 15.5 volts may be used. The plate current should be adjusted to 0.2 milliamperes with no a-c input signal. The grid bias voltage may con-

THE RCA RADIOTRON MANUAL

veniently be obtained from the voltage drop in a resistor between the cathode and ground. The value of this self-biasing resistance is not critical, 75000 to 100000 ohms being suitable. The higher value will allow the use of a larger input signal.

As an amplifier, the '37 is applicable to the audio or the radio-frequency stages of a receiver. Plate voltages and the corresponding grid voltages for amplifier service should be determined from CHARACTERISTICS and curves to obtain optimum performance and freedom from distortion.

As an oscillator, the recommended conditions are: Plate voltage, 45 volts (approximately); and grid bias, zero volts. It may be found desirable to use slightly lower values of plate voltage, depending upon the circuit design.

AVERAGE PLATE CHARACTERISTICS

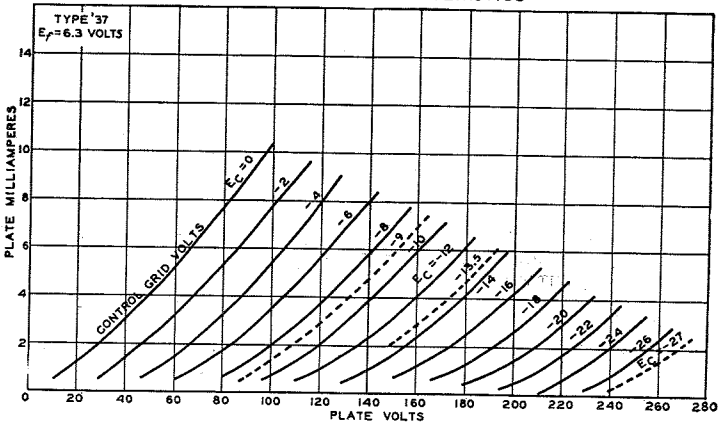

AVERAGE CHARACTERISTICS

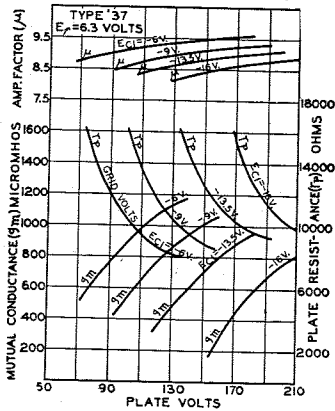

AVERAGE CHARACTERISTICS

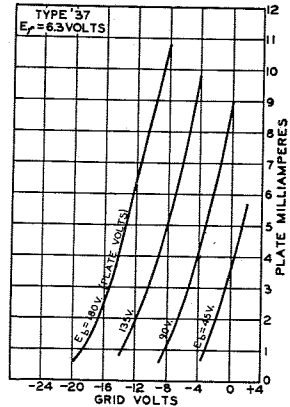

RCA Radiotron

RCA-238

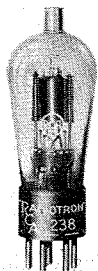

POWER AMPLIFIER PENTODE

The '38 is a power amplifier pentode for use in the output stage of automobile receivers and in sets operated from d-c power lines. It is capable of giving a large power output for a relatively small input signal voltage. The '38 contains a heater-cathode which is designed for d-c operation. Its design permits uniform tube operation over a comparatively wide range of heater voltages without appreciably affecting either performance or serviceability of the tube. This feature, together with that of the general freedom from microphonic and battery circuit disturbances makes the '38 well suited to mobile service and other applications where complete d-c operation is desirable.

CHARACTERISTICS

HEATER VOLTAGE (D. C.)	6.3	Volts
HEATER CURRENT	0.3	Ampere
PLATE VOLTAGE	100	135 max. Volts
SCREEN VOLTAGE	100	135 max. Volts
GRID VOLTAGE*	-9	-13.5 Volts
PLATE CURRENT	7	9 Milliamperes
SCREEN CURRENT	2	2.5 Milliamperes
PLATE RESISTANCE (Approx.)	84000	102000 Ohms
AMPLIFICATION FACTOR (Approx.)..	80	100
MUTUAL CONDUCTANCE	950	975 Micromhos
LOAD RESISTANCE	8500	13500 Ohms
POWER OUTPUT	200	525 Milliwatts
EFFECTIVE GRID-PLATE CAPACITANCE.	0.3	μf.
INPUT CAPACITANCE	4.1	μf.
OUTPUT CAPACITANCE	8.5	μf.
OVERALL LENGTH		4 ⁹ / ₃₂ " to 4 ¹⁷ / ₃₂ "
MAXIMUM DIAMETER		1 ¹ / ₁₆ "
BULB (See page 42, Fig. 9)		S-12
CAP		Small Metal
BASE		Small 5-Pin

* If the '38 is self-biased, the biasing resistor should be by-passed by a large condenser. With self-bias, the resistance of the grid circuit coupling should not exceed 1.0 megohm; without self-bias, the grid resistance should not exceed 0.5 megohm.

INSTALLATION

The base pins of the '38 fit the standard five-contact socket. The socket may be installed to hold the tube in any position. For socket connections, see page 39, Fig. 9.

For heater operation, refer to INSTALLATION for type '37.

The cathode circuit in most d-c receivers is usually tied in either directly or through biasing resistors to the negative side of the heater circuit. The potential difference thus introduced between heater and cathode should be kept as much as possible below the recommended maximum of 45 volts.

APPLICATION

For the power amplifier stage of radio receivers, the '38 is recommended either singly or in push-pull combination. More than one audio stage preceding the '38 is undesirable because of the possibility of microphonic disturbances resulting from the high level of amplification.

THE RCA RADIOTRON MANUAL

If a single '38 is operated self-biased, the self-biasing resistor for 135 volts on the plate should be approximately 1200 ohms. This resistor should be shunted by a condenser of 4 to 20 μf . to avoid degeneration effects at low audio frequencies. The use of two '38's in push-pull eliminates the necessity of by-passing the resistor. The self-biasing resistor required for the push-pull stage is approximately 600 ohms.

Any conventional type of **input coupling** may be used provided that the resistance added to the grid circuit by this device is not too high. Transformer or impedance coupling devices are preferable where the '38 follows a '37 detector. If a screen grid detector is used, however, resistance coupling or a combination of impedance-resistance coupling to the '38 will be better. A coupling condenser of 0.005 μf . will be suitable in such circuits.

An **output transformer** should be used to supply power to the winding of the reproducing unit. The optimum value of load resistance for the output device is 13500 ohms for a plate voltage of 135 volts and 8500 ohms for a plate voltage of 100 volts. For best results, the impedance in the plate circuit of the '38 over the entire audio-frequency range should be as uniform as possible.

AVERAGE PLATE CHARACTERISTICS

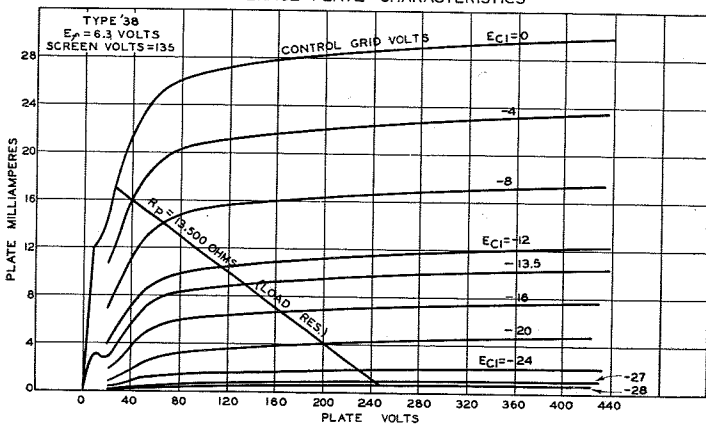

AVERAGE CHARACTERISTICS

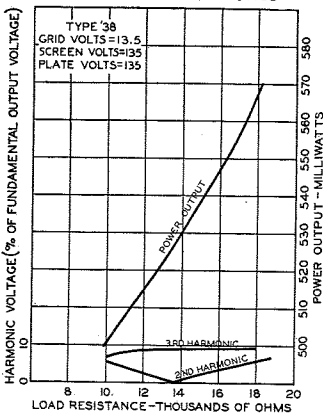

AVERAGE CHARACTERISTICS

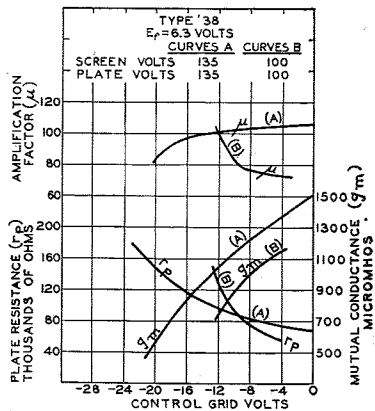

THE RCA RADIOTRON MANUAL

installed to hold the tube in any position. For socket connections, see page 39, Fig. 9.

The **heater** of the '39 is designed to operate satisfactorily from a 6-volt automobile storage battery without a rheostat or a fixed resistor, despite the voltage fluctuations during the charge and discharge periods. These variations in heater voltage do not seriously affect the performance or serviceability of this tube. The heater may be operated in series with the heaters of the '36, '37, or '38. This feature is especially desirable in receivers designed to operate from d-c house mains. Regardless of the number of heaters connected in series, the current in the heater circuit should be adjusted to 0.3 ampere for the normal supply voltage.

The **cathode** circuit in most d-c receivers is usually tied in either directly or through biasing resistors to the negative side of the heater circuit. The voltage difference thus introduced between heater and cathode should be kept as much as possible below the recommended maximum of 45 volts.

The positive **screen voltage** for the '39 may be obtained from a section of the B-battery, from a fixed or variable tap on a voltage divider across the supply voltage, or from a portion of the supply. Care should be taken to keep the impedance between the screen and cathode as low as possible.

When the '39 is self-biased, a resistor in series with the high voltage supply may be used for obtaining the screen voltage. This is possible because of the stable screen current characteristic of the '39 pentode. The resistor method of securing the screen voltage is limited to circuits where the screen voltage supply does not exceed 180 volts as a maximum. The value of this resistance should be such that under the conditions of minimum grid bias and maximum plate current the screen voltage will not exceed 90 volts. A resistance of approximately 80000 ohms will be suitable.

Complete **shielding** of all stages is necessary if maximum gain per stage is to be obtained.

AVERAGE PLATE CHARACTERISTICS

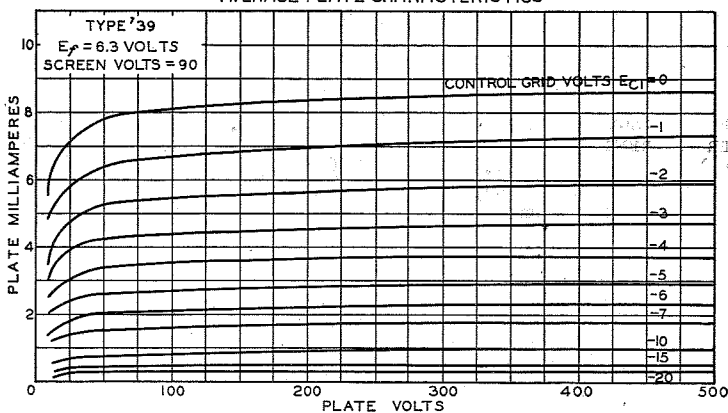

APPLICATION

As a radio-frequency and intermediate-frequency amplifier, the '39 should be operated as shown under CHARACTERISTICS. In general, properly designed radio-frequency transformers are preferable to interstage coupling impedances, especially in cases where a high impedance B-supply may cause oscillation below radio frequencies.

Volume control of receivers designed for the '39 may be accomplished by variation of the negative grid bias of this tube. In order to obtain adequate volume control, an available grid bias voltage of approximately 45 volts will be required.

THE RCA RADIOTRON MANUAL

The exact value will depend upon the circuit design and operating conditions. This voltage may be obtained from a potentiometer, a bleeder circuit, a variable resistor in the cathode circuit, or from a separate source. *In any event, the heater to cathode bias for the '39 should not exceed 45 volts.*

As a detector working directly into an audio-frequency amplifier, the '39 is not ordinarily suited. However, it does have a very useful application as the first detector in superheterodyne circuits and may be utilized to advantage in that position. Suitable operating voltages for such service are: Plate voltage, 90 to 180 volts; screen voltage, 90 volts; grid voltage, -7 volts (approx.). With variable bias on the first detector, the peak oscillator voltage should be preferably about one volt less than the minimum grid bias (approximately 7 volts). This practice will eliminate the possibility of cross-modulation caused by the first detector drawing grid current. Without variable bias on the first detector, the oscillator peak voltage should be considerably less than the grid bias to prevent grid current on very strong signal voltage swings.

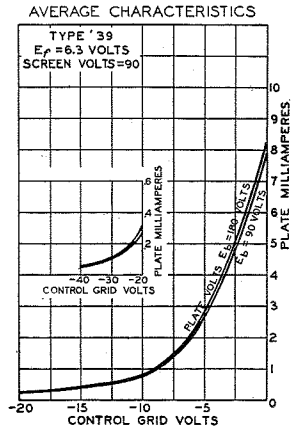
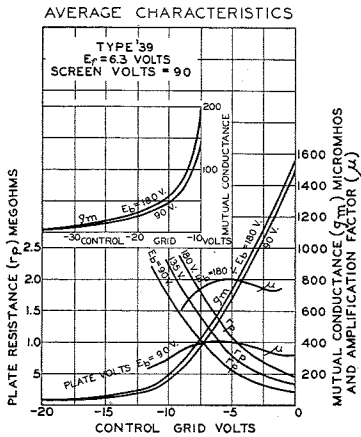

DIAGRAMMATIC SHORTWAVE RECEIVER
 6.3-VOLT HEATER TYPE TUBES

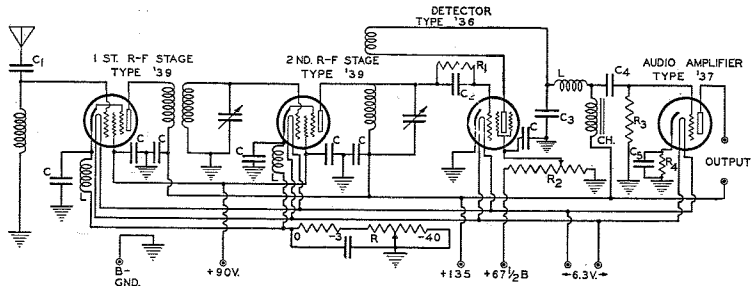

- C = R-F BY-PASS CONDENSER (0.01 μ f.)
- C₁ = ANTENNA COUPLING CONDENSER (APPROX. 30 μ f.)
- C₂ = GRID CONDENSER (0.00025 μ f.)
- C₃ = R-F BY-PASS CONDENSER (0.00025 μ f.)
- C₄ = COUPLING CONDENSER (0.005 μ f. TO 0.05 μ f.)
- C₅ = A-F BY-PASS CONDENSER (4 μ f. TO 8 μ f.)
- R = VOL. CONTROL (MIN. RESIST. ADJUSTED TO -3V, MAX. RESIST. TO -40V)
- R₁ = GRID LEAK RESISTOR (2 TO 5 MEGOHMS)
- R₂ = REGENERATION CONTROL POTENTIOMETER (50000 OHMS APPROX.)
- R₃ = GRID RESISTOR (1 MEGOHM MAX.)
- R₄ = SELF-BIASING RESISTOR (2000 OHMS APPROX.)
- L = RADIO-FREQUENCY CHOKE
- CH = PLATE CHOKE (300H. OR MORE)

NOTE: FOR LOUDSPEAKER RECEPTION SUBSTITUTE '38 FOR '37

RCA Radiotron

UX-245

POWER AMPLIFIER



The '45 is a power amplifier tube for supplying large undistorted output to a loudspeaker. It is for use as an audio-frequency output tube in a-c receivers using 2.5-volt heater and filament type tubes.

CHARACTERISTICS

FILAMENT VOLTAGE (A. C. or D. C.).....		2.5	Volts	
FILAMENT CURRENT		1.5	Amperes	
PLATE VOLTAGE	180	250	275 <i>max.</i>	Volts
GRID VOLTAGE*	-34.5	-50	-56	Volts
PLATE CURRENT	27	34	36	Milliamperes
PLATE RESISTANCE	1900	1750	1670	Ohms
AMPLIFICATION FACTOR	3.5	3.5	3.5	
MUTUAL CONDUCTANCE	1850	2000	2100	Micromhos
LOAD RESISTANCE	3500	3900	4600	Ohms
UNDISTORTED POWER OUTPUT	780	1600	2000	Milliwatts
GRID-PLATE CAPACITANCE		8		μf.
GRID-FILAMENT CAPACITANCE		5		μf.
PLATE-FILAMENT CAPACITANCE		3		μf.
MAXIMUM OVERALL LENGTH				5 ⁵ / ₈ "
MAXIMUM DIAMETER				2 ³ / ₁₆ "
BULB (See page 42, Fig. 10)				S-17
BASE				Medium 4-Pin

* Referred to mid-point of a-c operated filament. Self-bias is advisable in all cases and is required if a grid resistor (max. value of 1.0 megohm) is used.

INSTALLATION

The base pins of the '45 fit the standard four-contact socket which should be mounted preferably to hold the tube in a vertical position. If it is necessary to place the tube in a horizontal position, the socket should be mounted with the filament pin holes vertically one above the other. This precaution locates the filament plane vertical for most satisfactory performance. For socket connections, see page 39, Fig. 1. Provision should be made for free circulation of air around the tube since the bulb becomes quite hot during operation.

The coated **filament** of the '45 is designed to operate from the a-c line through a step-down transformer although it may be operated from a d-c source. In either case, the voltage applied to the filament terminals should be the rated value of 2.5 volts under conditions of load and normal line voltage.

APPLICATION

As a **power amplifier**, the '45 should be operated as indicated under CHARACTERISTICS. When a.c. is used on the filament, the plate and grid returns should be brought to (1) a mid-tapped resistor of from 20 to 40 ohms across the filament winding, or (2) to the mid-tap of the filament winding itself.

Grid bias for the '45 should be obtained by use of the voltage drop in a resistor connected in the negative plate-return lead. This scheme is known as the self-biasing method. The proper value of the resistor for a single '45 is 1550 ohm

THE RCA RADIOTRON MANUAL

for a plate voltage of 275 volts; 1475 ohms for a plate voltage of 250 volts; and 1275 ohms for a plate voltage of 180 volts.

If more output is desired than can be obtained from a single '45, two '45's may be operated either in parallel or push-pull connection. See page 13. When two '45's are operated together in the same amplifier stage, the values of the self-biasing resistors will be approximately one-half the values given above for a single tube.

An output device should be used to transfer power to the winding of the reproducing unit.

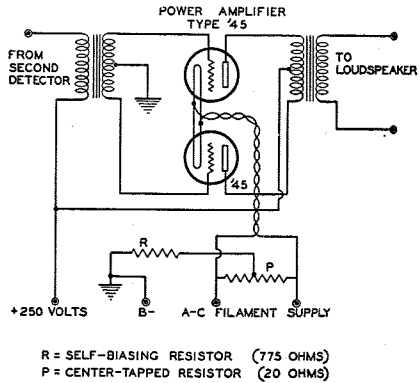
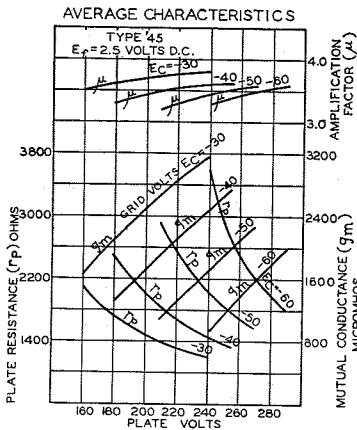
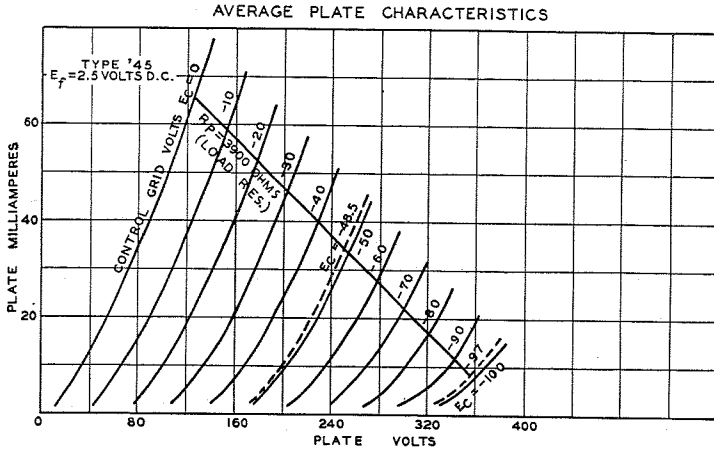

RCA Radiotron

RCA-46

DUAL-GRID POWER AMPLIFIER



The '46 is a double-grid power amplifier tube recommended especially for service in Class B amplifier circuits of suitable design. In such circuits an output stage is preceded by a power amplifier stage designated as the "driver." A pair of '46's in a Class B output stage is capable of supplying an exceptionally large amount of virtually undistorted power; while a single '46, operated in the driver stage as a Class A amplifier, can deliver sufficient power to drive the pair of '46's in the output stage.

The dual application of the '46 to Class B and to Class A amplifier service is made possible by different connections of the two grids incorporated in the tube's structure. Each grid terminates in its respective base pin. For Class B operation, the two grids must be tied together. This connection causes the tube to have an amplification factor so high that negative grid bias is not required for its operation as a Class B amplifier. For Class A operation, the grid adjacent to the plate is tied to the plate in order that the tube will have a low amplification factor. In the latter case, negative grid bias is required for proper operation of the tube. See page 15 for discussion of Class B operation.

CHARACTERISTICS

FILAMENT VOLTAGE (A. C. or D. C.).....	2.5	Volts
FILAMENT CURRENT	1.75	Amperes
MAXIMUM OVERALL LENGTH		5 ⁵ / ₈ "
MAXIMUM DIAMETER		2 ³ / ₁₆ "
BULB (See page 42, Fig. 10)		S-17
BASE		Medium 5-Pin

As Class B Amplifier

PLATE VOLTAGE	300	400 max.	Volts
GRID VOLTAGE (Both grids tied together) ..	0	0	Volts
PLATE CURRENT (Per tube)	4	6	Milliamperes
PEAK PLATE CURRENT (Per tube)	150	200	Milliamperes
MAX. PLATE DISSIPATION (Avg. per tube) ..	10	10	Watts
LOAD RESISTANCE (Per tube)	1300	1450	Ohms
MAX. SIGNAL VOLTAGE (RMS per tube)	40	41	Volts
MAX. CONTINUOUS POWER OUTPUT (Two tubes)*	16	20	Watts

As Class A Amplifier

PLATE VOLTAGE	250 max.	Volts
GRID VOLTAGE (Grid adjacent to plate tied to plate)	-33	Volts
PLATE CURRENT	22	Milliamperes
PLATE RESISTANCE	2380	Ohms
AMPLIFICATION FACTOR	5.6	
MUTUAL CONDUCTANCE	2350	Micromhos
LOAD RESISTANCE (For max. undistorted power)**..	6400	Ohms
MAX. UNDISTORTED POWER OUTPUT	1.25	Watts

* Power measured across indicated value of resistor in plate circuit of each tube, with indicated signal applied through 250 ohm resistance in the grid circuit.

** Approximately twice this value is recommended for load of driver for Class B stage.

INSTALLATION

The base of the '46 is of the medium five-pin type. Its pins fit the standard five-contact socket which may be installed to operate the tube either in a vertical or in

THE RCA RADIOTRON MANUAL

a horizontal position. For horizontal operation, the socket should be positioned with the filament pin openings one vertically above the other. For socket connections, see page 39, Fig. 7.

The **bulb** of this tube may become very hot under certain conditions of operation. Sufficient ventilation, therefore, should be provided around the tube to prevent overheating.

The **filament** is designed to operate at 2.5 volts. The transformer winding that supplies the filament circuit should operate the filament at this recommended value (as measured at the filament terminals) when rated voltage is applied to the primary of the power transformer operating under average load. The filament wiring should, insofar as possible, be isolated from the input circuit of the driver stage in order to avoid the possibility of hum caused by electrostatic induction from this wiring.

The grid and plate return for the driver stage should be made to a variable center-tapped resistor across the filament (or heater) supply for minimum hum adjustment. The use of a push-pull driver stage with either equi-potential or filament type tubes will reduce hum resulting from the filament supply, but is required only in special applications.

APPLICATION

For **Class B audio power amplifier service**, the '46 is particularly recommended because of its design. In this type of service, the two grids in the tube are connected together and, thus, the signal voltage is applied to both simultaneously. No grid bias voltage is necessary with this connection as the steady plate current at zero bias is only a few milliamperes. The design of the '46 permitting its operation as a Class B amplifier with zero bias is particularly important because it prevents variation of bias with applied signal which would otherwise exist if any self-bias arrangement were employed.

The direct-current requirements of Class B circuits are subject to fluctuation under operating conditions. The power supply, therefore, should have as good regulation as possible to maintain proper operating voltages regardless of the current drain. The use of a mercury-vapor rectifier in the power supply is recommended because it has a low and practically constant space-charge voltage drop within its operating range. As a further means of obtaining good regulation, the filter chokes and transformer windings of the power supply should have as low resistance as possible. In designing the power supply for a Class B amplifier, it should be remembered that such an amplifier may frequently demand peak currents of 200 milliamperes or more.

The grid of the '46 is operated sufficiently positive to cause grid current to flow in its input circuit. This feature imposes a further requirement on the preceding amplifier stage which must supply not only the necessary input voltage to the output stage, but it must be capable of doing so under conditions where appreciable power is taken by the grid of the Class B amplifier tube. Since the power necessary to swing the grid positive is partially dependent on the plate load of the Class B tube, and since the efficiency of power transfer from the preceding stage is dependent on transformer design, it is apparent that the design of a Class B audio power amplifier requires that more than ordinary attention be given to the effects produced by the component parts of the circuit. For this reason, the design of a Class B audio amplifier with its driver stage is somewhat more involved than for a Class A system.

In the design of Class B amplifiers, the interstage transformer is the link interconnecting the driver and the Class B stage. It is usually of the step-down type,

DYNAMIC TRANSFER CHARACTERISTICS

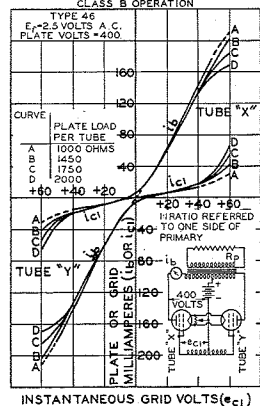

THE RCA RADIOTRON MANUAL

that is, the primary input voltage is higher than the secondary voltage supplied to the grids of the power output tubes. Depending upon conditions, the ratio of the primary of the interstage transformer to one-half of its secondary may range between 1.5 to 1 and 5.5 to 1. The transformer step-down ratio is dependent on the following factors: (1) Type of driver tube, (2) Type of power tube, (3) Load on power tube, (4) Permissible distortion, and (5) Transformer efficiency (peak power).

The primary impedance of the interstage transformer is essentially the same as if the transformer were to be operated with no load, that is, into an open grid. Since power is transferred, the transformer should have reasonable power efficiency. It should be noted that the power output and distortion are often critically dependent upon the circuit constants which should therefore be made as near independent of frequency as possible. This applies particularly to the interstage coupling transformer and to the loudspeaker.

The driver tube should be capable of delivering sufficient power to operate the Class B amplifier stage. If low distortion is desired, it is most important that the driver tube be worked substantially below its Class A undistorted output rating, since distortion produced by the driver stage and the power stage will be present in the output.

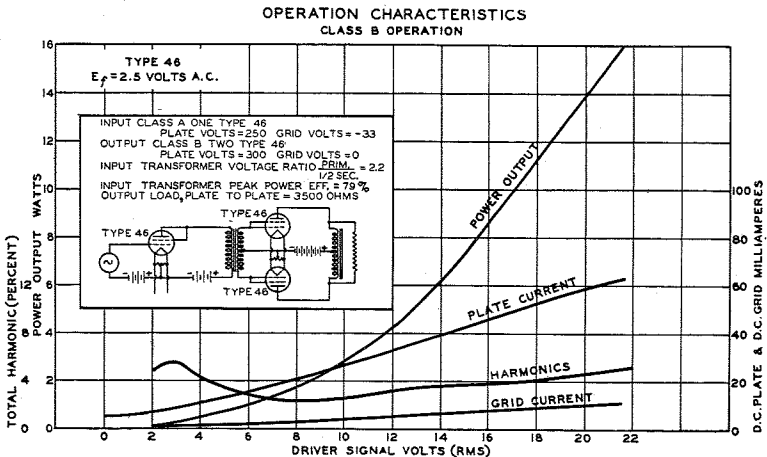
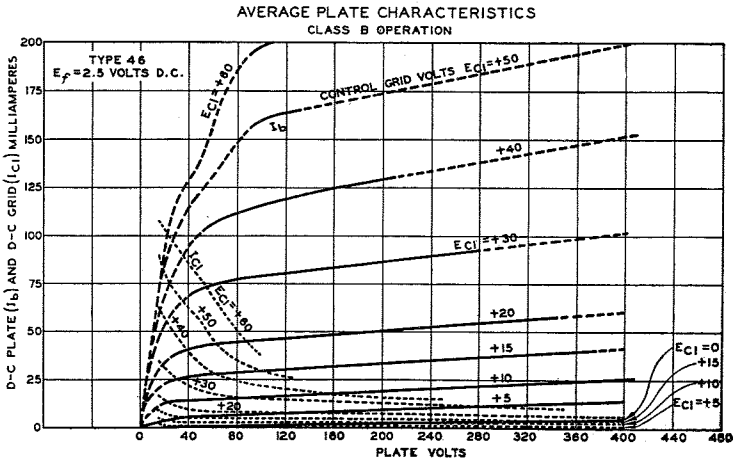

THE RCA RADIOTRON MANUAL

For **Class A operation** of the '46, the grid adjacent to the plate is connected to the plate. The grid next to the filament serves as the control grid. Operation of the tube is then similar to any Class A power amplifier triode. The operation of this tube connected as a Class A amplifier is not indicative of its performance in Class B circuits and should not be confused with the latter.

The intended application of the '46 as a Class A amplifier is for driving two '46's in a Class B amplifier circuit. The tube has been constructed for this dual service in order to reduce the number of tube types necessary in a receiver. The tabulated values for Class A operation of this type as given under CHARACTERISTICS are for its operation as a power output tube.

**AVERAGE PLATE CHARACTERISTICS
CLASS A OPERATION**

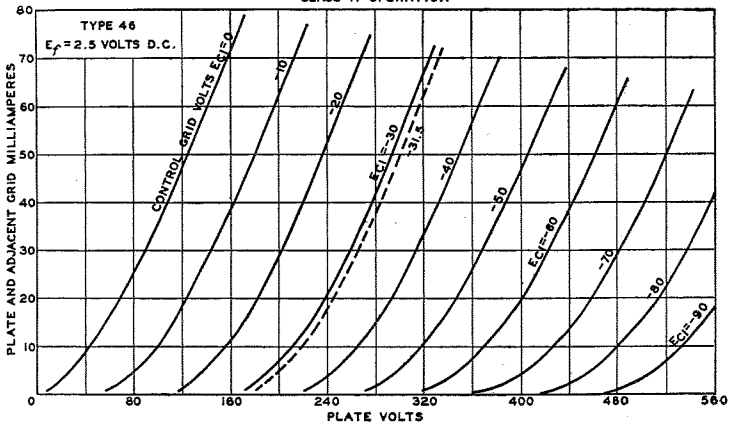

**AVERAGE CHARACTERISTICS
CLASS A OPERATION**

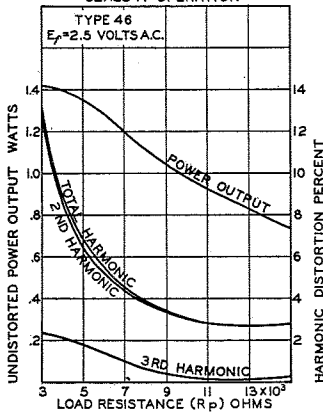

**AVERAGE CHARACTERISTICS
CLASS A OPERATION**

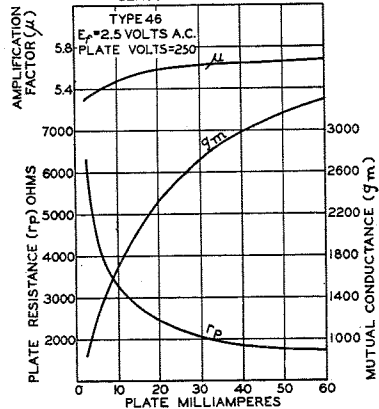

RCA Radiotron

RCA-247

POWER AMPLIFIER PENTODE

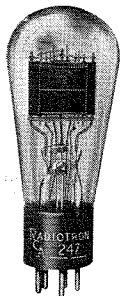

The '47 is a power amplifier pentode for use in the audio output stage of a-c receivers. It is capable of giving large power output with a relatively small input signal voltage. In comparison with three-electrode power amplifiers of the same plate dissipation, the '47 is capable of greater power output with the additional feature of higher amplification. This power-handling ability of the '47 is made possible by the addition of both a suppressor and a screen between the grid and plate. (See page 5 for further information on pentodes.)

CHARACTERISTICS

FILAMENT VOLTAGE (A. C. or D. C.).....	2.5	Volts
FILAMENT CURRENT	1.75	Amperes
PLATE VOLTAGE	250 <i>max.</i>	Volts
SCREEN VOLTAGE	250 <i>max.</i>	Volts
GRID VOLTAGE*	-16.5	Volts
PLATE CURRENT	31	Milliamperes
SCREEN CURRENT	6.0	Milliamperes
PLATE RESISTANCE	60000	Ohms
AMPLIFICATION FACTOR	150	
MUTUAL CONDUCTANCE	2500	Micromhos
LOAD RESISTANCE	7000	Ohms
POWER OUTPUT	2500	Milliwatts
EFFECTIVE GRID-PLATE CAPACITANCE	1.25	$\mu\text{f.}$
INPUT CAPACITANCE	8.7	$\mu\text{f.}$
OUTPUT CAPACITANCE	13.2	$\mu\text{f.}$
MAXIMUM OVERALL LENGTH		5 $\frac{5}{8}$ "
MAXIMUM DIAMETER		2 $\frac{3}{16}$ "
BULB (See page 42, Fig. 10)		S-17
BASE		Medium 5-Pin

* If filament is operated on d.c., grid bias should be -15.3 volts.

INSTALLATION

The base pins of the '47 fit the standard five-contact socket which should be mounted preferably to hold the tube in a vertical position. For socket connections, see page 39, Fig. 6. If it is necessary to place the tube in a horizontal position, the socket should be mounted with its filament pin openings one vertically above the other. Provision should be made for free circulation of air around the tube since the bulb becomes quite hot during operation.

The coated filament of the '47 is intended for operation from a 2.5-volt winding of the power transformer. The voltage applied to the filament terminals should be the rated value of 2.5 volts under operating conditions and average line voltage.

APPLICATION

For the power amplifier stage of radio receivers, the '47 is recommended either singly or in push-pull combination. More than one audio stage preceding the '47 is undesirable because of the possibility of microphonic disturbances resulting from the high level of amplification.

If a single '47 is operated self-biased, the self-biasing resistor should be approximately 450 ohms. This resistor should be shunted by a condenser of 4 to 20 $\mu\text{f.}$

THE RCA RADIOTRON MANUAL

to avoid degeneration effects at low audio frequencies. The use of two '47's in push-pull eliminates the necessity of by-passing the resistor and is, in addition, effective in reducing hum from filter circuits. The self-biasing resistor required for the push-pull stage is approximately 225 ohms.

Any conventional type of **input coupling** may be used, provided that the resistance added to the grid circuit by this device is not too high. Transformer or impedance coupling devices are preferable. If input-resistance coupling is used, a grid resistance not to exceed 0.5 megohm may be employed under self-bias conditions. Without self-bias, the grid leak resistance should not exceed 50000 ohms.

An **output transformer** should be used in order to supply power to the winding of the reproducing unit. The optimum value of load resistance for the output device is 7000 ohms. For best results, the impedance in the plate circuit of the '47 over the entire audio-frequency range should be as uniform as possible.

The blue glow which frequently appears on the inner surface of the '47 bulb is due to fluorescence caused by stray electrons from the filament which strike the interior of the getter-coated bulb. This fluorescence is a natural effect and is in no manner an indication of the performance of the tube.

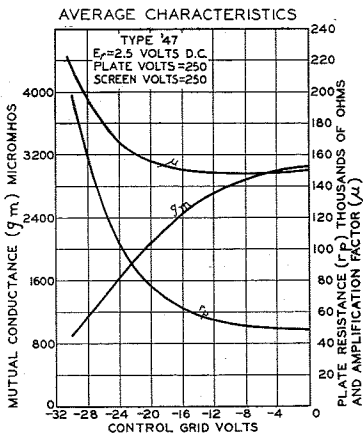
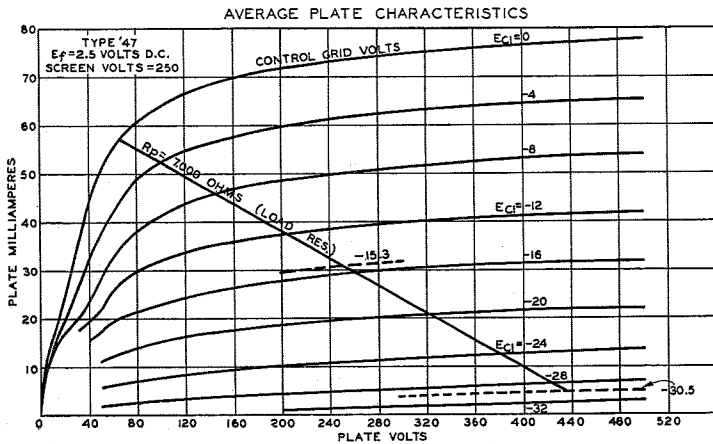

AVERAGE OUTPUT CHARACTERISTICS

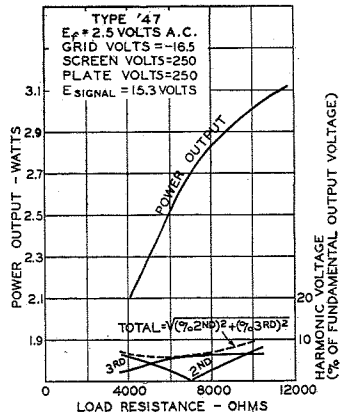

RCA Radiotron

UX-250

POWER AMPLIFIER



The '50 is a power amplifier tube designed for use primarily in the output stage of an audio-frequency amplifier employing transformer coupling. It is capable of delivering unusually large amounts of undistorted power.

CHARACTERISTICS

FILAMENT VOLTAGE (A. C. or D. C.).....		7.5	Volts
FILAMENT CURRENT		1.25	Amperes
PLATE VOLTAGE	350 400	450 <i>max.</i>	Volts
GRID VOLTAGE*	-63 -70	-84	Volts
PLATE CURRENT	45 55	55	Milliamperes
PLATE RESISTANCE	1900 1800	1800	Ohms
AMPLIFICATION FACTOR	3.8 3.8	3.8	
MUTUAL CONDUCTANCE	2000 2100	2100	Micromhos
LOAD RESISTANCE	4100 3670	4350	Ohms
UNDISTORTED POWER OUTPUT	2400 3400	4600	Milliwatts
GRID-PLATE CAPACITANCE		9	μ f.
GRID-FILAMENT CAPACITANCE		5	μ f.
PLATE-FILAMENT CAPACITANCE		3	μ f.
MAXIMUM OVERALL LENGTH			6 $\frac{1}{4}$ "
MAXIMUM DIAMETER			2 $\frac{11}{16}$ "
BULB (See page 42, Fig. 13)			S-21
BASE			Medium 4-Pin Bayonet

* Measured from mid-point of a-c operated filament.

INSTALLATION

The base pins of the '50 fit the standard four-contact socket which should be mounted to hold the tube in a vertical position. For socket connections, see page 39, Fig. 1. Provision should be made for free circulation of air around the tube, since the bulb becomes quite hot during operation.

The coated filament is designed to operate from a 7.5 volt winding of the power transformer. However, if desirable, it may be operated equally as well from a d-c source. In either case the voltage applied to the filament terminals should be the rated value of 7.5 volts.

APPLICATION

As a power amplifier, the '50 should be operated as shown under CHARACTERISTICS. Grid bias voltage may be conveniently obtained by means of the voltage drop through a resistor in the plate return lead. The proper value of this resistor is 1400 ohms for a plate voltage of 350 volts; 1275 ohms for a plate potential of 400 volts; and 1530 ohms for a plate potential of 450 volts. The '50 is not recommended for use in resistance-coupled circuits having a grid resistor.

If more output is desired than can be obtained from a single '50, two '50's may be operated either in parallel or push-pull connection. See page 13. When two '50's are operated together in the same amplifier stage, the values of the self-biasing resistors will be approximately one-half those shown above for a single tube.

RCA Radiotron

RCA-56



SUPER-TRIODE AMPLIFIER

The 56 is a three-electrode tube of the uni-potential heater-cathode type recommended for use as detector, amplifier, or oscillator in a-c receivers designed for it. This tube is characterized by its small overall size, its relatively low heater power consumption, its high mutual conductance, and its comparatively high amplification factor. The 56 is especially useful in resistance-coupled audio-frequency amplifiers.

CHARACTERISTICS

HEATER VOLTAGE (A. C. or D. C.)	2.5	Volts
HEATER CURRENT	1.0	Ampere
PLATE VOLTAGE	250 max.	Volts
GRID VOLTAGE*	-13.5	Volts
PLATE CURRENT	5	Milliamperes
PLATE RESISTANCE	9500	Ohms
AMPLIFICATION FACTOR	13.8	
MUTUAL CONDUCTANCE	1450	Micromhos
GRID-PLATE CAPACITANCE	3.2	$\mu\text{f.}$
GRID-CATHODE CAPACITANCE	3.2	$\mu\text{f.}$
PLATE-CATHODE CAPACITANCE	2.2	$\mu\text{f.}$
MAXIMUM OVERALL LENGTH		4 $\frac{1}{4}$ "
MAXIMUM DIAMETER		1 $\frac{9}{16}$ "
BULB (See page 42, Fig. 6)		S-12
BASE		Small 5-Pin

* If a grid coupling resistor is used, its maximum value should not exceed 1.0 megohm.

INSTALLATION

The base of the 56 is of the small five-pin type. Its pins fit the standard five-contact socket which may be installed to operate the tube either in a vertical or in a horizontal position. For horizontal operation, the socket should be positioned with its heater pin openings one vertically above the other. For socket connections, see page 39, Fig. 8.

The heater is designed to operate at 2.5 volts. The transformer winding supplying the heater circuit should be designed to operate the heater at this recommended value (as measured at the heater terminals) when rated voltage is applied to the primary of the power transformer operating under average load.

The cathode should be connected either to the mid-tap on the heater supply winding or to the mid-tap of a 50 ohm (approximate) resistor shunted across the winding. If this practice is not followed, the heater may be biased negative with respect to the cathode by not more than 45 volts. When the cathode is not connected directly to the heater in a-c receivers, attention should be given to keeping the impedance of the circuit between heater and cathode as low as possible. Unless this is done, hum may arise because of heater to cathode leakage.

APPLICATION

As an amplifier, the 56 is applicable either to radio-frequency or audio-frequency circuits. Recommended operating conditions for service using transformer coupling are given under CHARACTERISTICS. For circuits utilizing resistance coupling, typical operating conditions are as follows: Plate supply voltage, 250 volts; grid bias voltage,

THE RCA RADIOTRON MANUAL

-9 volts (approximate); plate load resistor, 50000 to 100000 ohms; and plate current, 1 to 2 milliamperes.

As a **detector**, the 56 may be of the grid leak and condenser or grid bias type. The plate voltage for the grid leak and condenser method should be about 45 volts. A grid leak of from 1 to 5 megohms with a grid condenser of 0.00025 μf . is satisfactory. For the grid bias method of detection, the maximum plate supply voltage of 250 volts may be used together with a negative grid bias voltage of approximately 20 volts. The plate current should be adjusted to 0.2 milliampere with no a-c input signal voltage. The grid bias voltage may be supplied from the voltage drop in a resistor between cathode and ground. The value of this self-biasing resistor is not critical, 100000 to 150000 ohms being suitable. The higher value will permit the application of a larger input signal.

The 56 may be employed as a two-electrode detector preferably by connecting the plate to the cathode for the one electrode and using the grid for the other. With this arrangement, a-c input voltages as high as 40 volts RMS may be applied between grid and cathode.

As an **oscillator**, the 56 may be operated with a plate voltage of approximately 90 volts and zero grid bias. A lower value of plate voltage may be found desirable in some applications.

AVERAGE PLATE CHARACTERISTICS

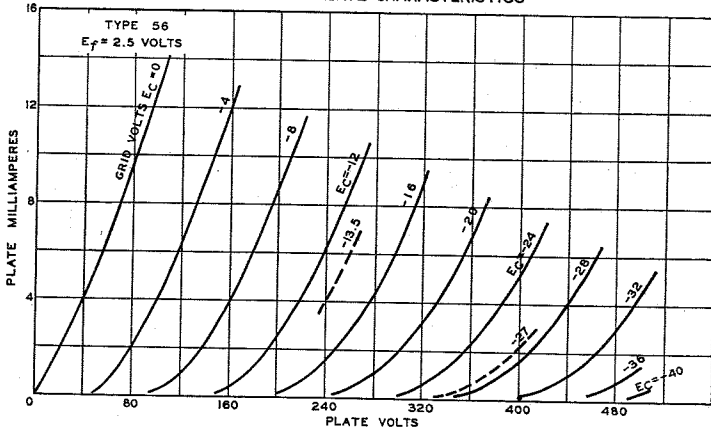

RESISTANCE-COUPLED A-F AMPLIFIER

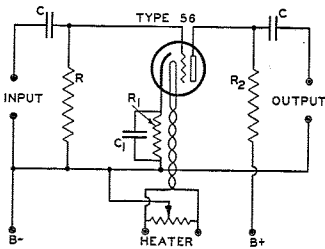

- R = GRID RESISTOR (1.0 MEGOHM, MAX)
- R_1 = SELF-BIASING RESISTOR (3000 OHMS)
- R_2 = COUPLING RESISTOR (50000 TO 100000 OHMS)
- C = COUPLING CONDENSER (0.1 μf - 1.0 μf)
- C_1 = BY-PASS CONDENSER (4 μf)

AVERAGE CHARACTERISTICS

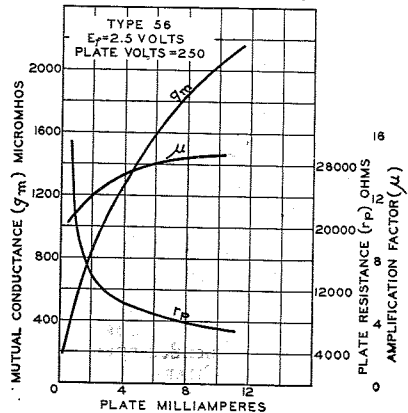

RCA Radiotron

RCA-57

TRIPLE-GRID AMPLIFIER



The 57 is a triple-grid tube recommended especially for service as a biased detector in a-c receivers designed for its characteristics. In such service, this tube is capable of delivering a large audio-frequency output voltage with relatively small input voltage. Other applications of the 57 include its use as a low signal-input, screen grid amplifier tube and as an automatic volume control tube. The 57 is characterized by the small overall size, the dome-top bulb, the internal shield in the dome, the rigidity of electrode assembly, and the fifth electrode or suppressor with its own base pin terminal. Equally significant among its electrical features are its relatively low heater power consumption, its sharp plate current "cut-off" with respect to grid voltage, and its adaptability of electrode combinations to unusual circuit applications.

The internal shield is a distinctive feature in the design of this tube. It is placed in the bulb dome above the electrode assembly and is connected within the tube directly to the cathode. The dome-top bulb makes possible close proximity of the external and internal shields and, therefore, a low effective grid-plate capacitance. The form of the external shield can may be somewhat modified depending upon the receiver design requirements for minimum grid-plate and output capacitance.

CHARACTERISTICS

HEATER VOLTAGE (A. C. or D. C.)	2.5	Volts
HEATER CURRENT	1.0	Ampere
PLATE VOLTAGE	250 <i>max.</i>	Volts
SCREEN VOLTAGE	100 <i>max.</i>	Volts
GRID VOLTAGE	-3	Volts
PLATE CURRENT	2.0	Milliamperes
SCREEN CURRENT	1.0	Milliampere
PLATE RESISTANCE	Greater than 1.5	Megohms
AMPLIFICATION FACTOR	Greater than 1500	
MUTUAL CONDUCTANCE	1225	Micromhos
EFFECTIVE GRID-PLATE CAPACITANCE (with shield can)	0.010 <i>maximum</i>	μ f.
INPUT CAPACITANCE	5.2	μ f.
OUTPUT CAPACITANCE	6.8	μ f.
OVERALL LENGTH		$4\frac{1}{32}$ " to $4\frac{27}{32}$ "
MAXIMUM DIAMETER		$1\frac{1}{16}$ "
BULB (See page 42, Fig. 7)		ST-12
CAP		Small Metal
BASE		Small 6-Pin

INSTALLATION

The base pins of the 57 fit the standard 6-contact socket which may be installed to hold the tube either in a vertical or in a horizontal position. For horizontal operation, the socket should be positioned with its heater pin openings one vertically above the other. For socket connections, see page 39, Fig. 11.

For heater operation and cathode connection, refer to INSTALLATION for type 56.

The screen voltage may be obtained from a potentiometer or bleeder circuit across the B-supply source. Due to the screen current characteristics of the 57, the use of a resistor in series with the high voltage supply may be employed for obtaining the screen voltage provided the cathode-resistor method of bias control is

THE RCA RADIOTRON MANUAL

used. This method, however, is not recommended if the high voltage B-supply exceeds 250 volts.

Complete **shielding** of detector circuits employing the 57 is generally necessary, since considerable voltage at carrier frequency is usually present in the plate circuit even though the latter is by-passed with a low impedance capacitor. Two-section filters in the plate circuit are frequently necessary to prevent radio-frequency feed-back to the input of the detector.

In receivers employing a built-in loudspeaker, acoustic shielding may be necessary to prevent microphonic feed-back when a strong radio-frequency carrier voltage is present on the tube elements. It should be noted also that condenser plates may cause an audio howl due to mechanical feed-back from the speaker.

APPLICATION

As a **biased detector**, the 57 is particularly recommended because of its ability to deliver a large audio-frequency output voltage of good quality with a fairly small radio-frequency signal input. Recommended conditions for the 57 as a biased detector are as follows: Plate voltage, 250 volts; screen voltage, 100 volts; grid bias voltage, -6 volts (approx.); plate load, 250000 ohm resistor, or a 500 henry choke shunted by a 0.25 megohm resistor. For resistance load, the plate voltage will be the supply voltage minus the voltage drop in load caused by specified plate current (adjusted to 0.1 milliampere with no a-c input signal).

Detector bias may be obtained from a bleeder circuit, from a resistor in the cathode circuit, or from a partial self-biasing circuit. The cathode-resistor method permits of higher output at low percentage modulation since the input signal may be increased almost in inverse proportion to the modulation without resulting in objectionable distortion.

As a **radio-frequency amplifier**, the 57 may be used particularly in applications where the r-f signal applied to the grid is relatively low, that is, of the order of a few volts. In such cases either screen or control grid voltage (or both) may be varied to control the receiver volume. When larger signals are involved, a super-control amplifier tube should be employed to prevent the occurrence of excessive cross-modulation and modulation distortion. Recommended operating conditions for amplifier service are given under CHARACTERISTICS.

As a **frequency converter** or a superheterodyne first detector, the 57 may be employed but a tube having super-control characteristics is to be preferred, especially if signals of large magnitude are to be received, and if supplementary volume control is to be obtained in this stage.

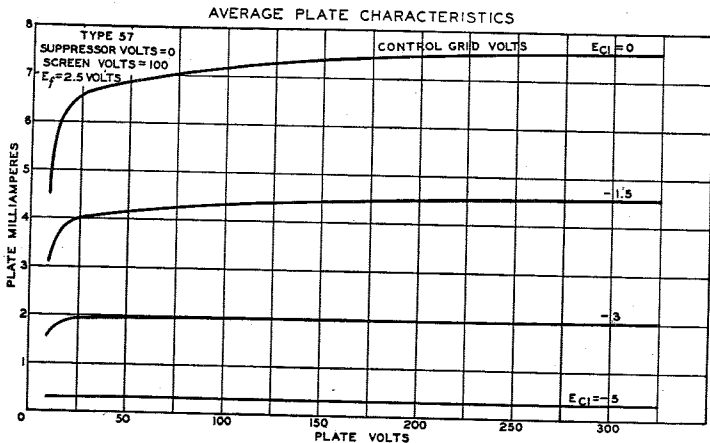

RCA Radiotron

RCA-58



TRIPLE-GRID SUPER-CONTROL AMPLIFIER

The 58 is a triple-grid super-control amplifier tube recommended especially for service in the radio-frequency and intermediate-frequency stages of a-c receivers designed for its characteristics. The 58 is characterized by the small overall size, the dome-top bulb, and the fifth electrode or suppressor with its own base pin terminal. Equally significant among its electrical features are the relatively low heater power consumption, the extended mutual conductance operating range, and the adaptability of electrode combinations to various circuit applications. The ability of this tube to handle usual signal voltages without cross-modulation and modulation-distortion makes it uniquely adaptable to the r-f and i-f stages of receivers employing automatic volume control. Shield construction and bulb shape are discussed under Type 57, which is similar in structural appearance.

When the suppressor is not connected directly to the cathode, its utility may be extended. The suppressor, in suitable circuits, provides a means for obtaining the desirable conditions of reduced selectivity for local reception. This operational characteristic makes possible improved loudspeaker response when the receiver is tuned to powerful nearby stations.

CHARACTERISTICS

HEATER VOLTAGE (A. C. or D. C.)	2.5	Volts	
HEATER CURRENT	1.0	Ampere	
PLATE VOLTAGE	250 <i>max.</i>	Volts	
SCREEN VOLTAGE	100 <i>max.</i>	Volts	
GRID VOLTAGE	-3 <i>min.</i>	Volts	
PLATE CURRENT	8.2	Milliamperes	
SCREEN CURRENT	3.0 <i>max.</i>	Milliamperes	
PLATE RESISTANCE	800000	Ohms	
AMPLIFICATION FACTOR	1280		
MUTUAL CONDUCTANCE	1600	Micromhos	
MUTUAL CONDUCTANCE	{ At -40 volts bias.....	10	Micromhos
	{ At -50 volts bias.....	2	Micromhos
EFFECTIVE GRID-PLATE CAPACITANCE (with shield-can)	0.010 <i>maximum</i>	$\mu\text{f.}$	
INPUT CAPACITANCE	5.2	$\mu\text{f.}$	
OUTPUT CAPACITANCE	6.8	$\mu\text{f.}$	
OVERALL LENGTH		41 $\frac{1}{32}$ " to 42 $\frac{7}{32}$ "	
MAXIMUM DIAMETER		1 $\frac{3}{16}$ "	
BULB (See page 42, Fig. 7)		ST-12	
CAP		Small Metal	
BASE		Small 6-Pin	

INSTALLATION

The base pins of the 58 fit the standard six-contact socket which may be installed to hold the tube either in a vertical or in a horizontal position. For horizontal operation, the socket should be positioned with its heater pin openings one vertically above the other. For socket connections, see page 39, Fig. 11.

The heater is designed to operate at 2.5 volts. The transformer winding supplying the heater circuit should be designed to operate the heater at this recommended value for full load operating conditions under average line voltage.

For cathode connection, refer to cathode, type 56.

Control grid bias variation will be found effective in changing the volume of the receiver. In order to obtain adequate volume control, an available grid bias voltage

THE RCA RADIOTRON MANUAL

of approximately 50 volts will be required. The exact value will depend upon the circuit design and operating conditions. This voltage may be obtained, depending on receiver requirements, from a potentiometer across a fixed supply voltage or by the use of a variable self-bias resistor in the cathode circuit.

The screen voltage may be obtained from a potentiometer or bleeder circuit across the B-supply source. Due to the screen current characteristics of the 58, a resistor in series with the high-voltage supply may be employed for obtaining the screen voltage provided the cathode-resistor method of bias control is used. This method, however, is not recommended if the high voltage B-supply exceeds 250 volts. Furthermore, it should be noted that the use of a resistor in the screen circuit will have an effect on the change in plate resistance with variation in suppressor voltage in case the suppressor is utilized for control purposes.

The suppressor may be connected directly to the cathode or it may be made negative with respect to the cathode. For the latter condition, the suppressor voltage may be obtained from a potentiometer or bleeder circuit for manual volume and selectivity control, or from the drop in a resistor in the plate circuit of the automatic volume control tube.

Shielding requirements are similar to those for type 57.

APPLICATION

As a radio-frequency amplifier, the 58 is especially applicable to radio receiver design because of its ability to reduce cross-modulation effects, its remote "cut-off" feature, and its flexible adaptability to circuit combinations and to receiver design. Recommended conditions for the 58 as an amplifier are given under CHARACTERISTICS.

To realize the maximum benefit of the long "cut-off" feature of this tube, it is necessary to apply a variable grid bias and to maintain the screen at a constant potential with respect to the cathode. However, good results may be obtained by using a variable cathode resistance which, of course, reduces the screen potential with respect to the cathode by the same amount that the bias is increased, thus hastening the "cut-off" and reducing the ability of the tube to handle large signals. This undesirable effect may be nullified by means of a series resistor in the screen circuit.

The use of series resistors for obtaining satisfactory control of screen voltage in the case of four-electrode tubes is usually impossible because of secondary emission phenomena. In the 58, however, the suppressor practically removes these effects and it is therefore possible to obtain satisfactorily the screen voltage from the plate supply or from some high intermediate voltage providing these sources do not exceed 250 volts. With this method, the screen to cathode voltage will fall off very little from minimum to maximum value of cathode-control resistor. In some cases, it may actually rise. This rise of screen to cathode voltage above the normal maximum value is allowable because the screen and the plate current are reduced simultaneously by a sufficient amount to prevent damage to the tube. It should be recognized in general that the series resistor method of obtaining screen voltage from a higher voltage supply necessitates the use of the variable cathode-resistor method of controlling volume. When screen and control grid voltages are obtained in this manner, the remote "cut-off" advantage of the 58 may be fully realized.

As a frequency converter or a superheterodyne first detector, the 58 may be used to advantage. It is capable of producing under the proper conditions of grid and local oscillator voltage, a gain in the first detector stage of about one-third that which can be obtained in an intermediate-frequency amplifier stage. In addition, this gain can be controlled as in the case of the radio-frequency amplifier by varying the grid bias either from a separate supply or from a variable resistor in the cathode circuit. This is a particularly desirable feature in receivers employing automatic volume control, because it enables a much lower threshold input to be received without loss of amplification and permits the reception of high input voltages without loss of control. Recommended conditions for the 58 as a superheterodyne first detector follow: Plate voltage, 250 volts; screen voltage, 100 volts; and

THE RCA RADIOTRON MANUAL

grid bias voltage, -10 volts minimum (with 9-volt oscillator peak swing). With an oscillator peak swing of 1 volt less than the grid bias, these values are not critical and may be chosen to meet circuit design requirements.

As a **grid bias detector**, the 58 is not recommended. This is because the intentional elimination of a definite "cut-off" makes the 58 rather insensitive and renders any approach to linear detection impracticable.

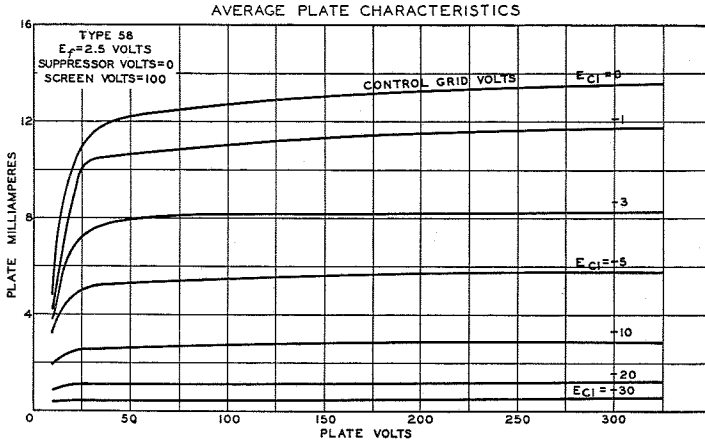

AVERAGE CHARACTERISTICS

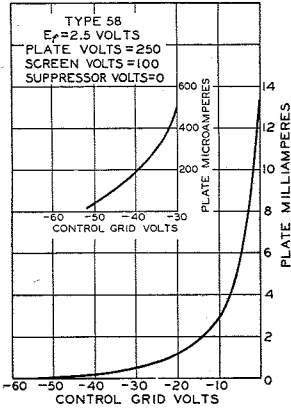

AVERAGE CHARACTERISTICS

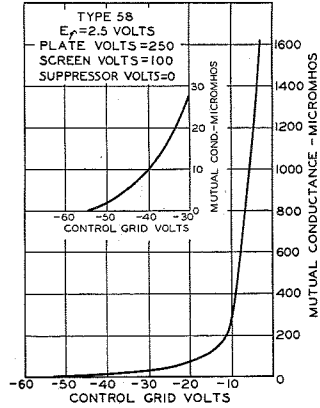

RCA Radiotron

UX-171-A

POWER AMPLIFIER

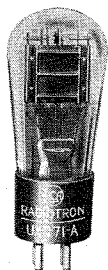

The '71-A is a power amplifier tube of low output impedance for use in the output stage of audio-frequency amplifiers.

CHARACTERISTICS

FILAMENT VOLTAGE (D. C.)	5.0	Volts
FILAMENT CURRENT	0.25	Ampere
PLATE VOLTAGE	90 135 180 max.	Volts
GRID VOLTAGE*	-16.5 -27 -40.5	Volts
PLATE CURRENT	12 17.5 20	Milliamperes
PLATE RESISTANCE	2250 1960 1850	Ohms
AMPLIFICATION FACTOR	3 3 3	
MUTUAL CONDUCTANCE	1330 1520 1620	Micromhos
LOAD RESISTANCE	3200 3500 5350	Ohms
UNDISTORTED POWER OUTPUT	125 370 700	Milliwatts
GRID-PLATE CAPACITANCE	7.4	μ f.
GRID-FILAMENT CAPACITANCE	3.7	μ f.
PLATE-FILAMENT CAPACITANCE	2.1	μ f.
MAXIMUM OVERALL LENGTH		4 $\frac{1}{16}$ "
MAXIMUM DIAMETER		1 $\frac{3}{16}$ "
BULB (See page 42, Fig. 8)		S-14
BASE		Medium 4-Pin

* For operation on a-c filament supply, increase grid bias voltage 2.5 volts.

INSTALLATION

The base pins of this tube fit the standard four-contact socket. The socket should be installed so that the tube will operate in a vertical position. For socket connections, see page 39, Fig. 1.

The coated filament of the '71-A may be operated from a storage battery or from the a-c line through a step-down transformer. For operation of this tube from a storage battery, a fixed or variable resistor of suitable value is required to reduce the battery voltage to 5.0 volts across the filament terminals at the socket. Most satisfactory operating performance of the tube will be obtained at the rated filament voltage.

APPLICATION

Operating conditions are given under CHARACTERISTICS for the use of this tube in the power output stage. With a d-c filament supply, the grid and the plate return should be made to the negative filament terminal.

For a-c filament supply, the plate and the grid return should be brought either to a mid-tapped resistor of 20 to 40 ohms across the filament winding, or to a mid-tap of the filament winding. To prevent overloading and distortion, the recommended negative grid bias should always be used.

Grid bias for the '71-A may be obtained from a C-battery or by means of the voltage drop in a resistor connected in the negative plate return lead. This second method is known as the self-biasing method, since the plate current determines the

THE RCA RADIOTRON MANUAL

drop. It is not, however, generally applicable to battery operated receivers. The proper value of this resistor for a plate voltage of 180 volts is 2150 ohms; for a plate voltage of 135 volts, 1700 ohms; and for 90 volts, 1600 ohms.

If more output is desired than can be obtained from a single '71, two '71's may be operated either in parallel or push-pull connection. See page 13. When two '71's are operated together in the same amplifier stage, the values of the self-biasing resistors will be approximately one-half the values given above for a single tube.

An output device should be used to transfer power to the winding of the reproducing unit.

AVERAGE PLATE CHARACTERISTICS

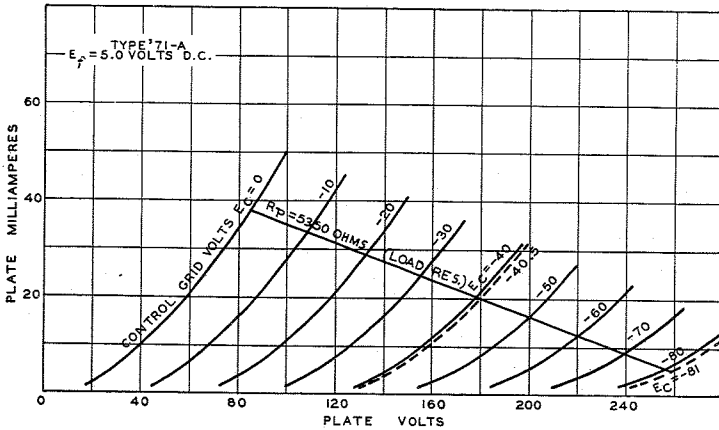

AVERAGE CHARACTERISTICS

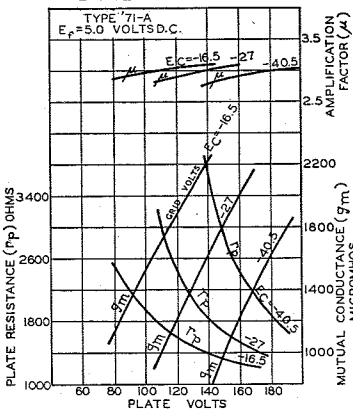

AVERAGE CHARACTERISTICS

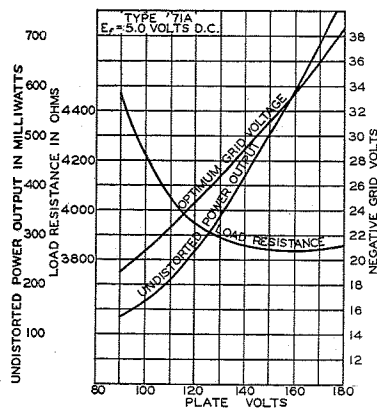



RCA Radiotron

UX-280

FULL-WAVE RECTIFIER

The '80 is a full-wave rectifying tube intended for use in d-c power supply devices which operate from the a-c supply line.

CHARACTERISTICS

FILAMENT VOLTAGE (A. C.)	5.0	Volts
FILAMENT CURRENT	2.0	Amperes
1 { A-C VOLTAGE PER PLATE (RMS)	350	Volts
{ D-C OUTPUT CURRENT	125 max.	Milliamperes
2 { A-C VOLTAGE PER PLATE (RMS)	400 max.	Volts
{ D-C OUTPUT CURRENT	110 max.	Milliamperes
3* { A-C VOLTAGE PER PLATE (RMS)	550 max.	Volts
{ D-C OUTPUT CURRENT	135 max.	Milliamperes
MAXIMUM OVERALL LENGTH		5 $\frac{5}{8}$ "
MAXIMUM DIAMETER		2 $\frac{3}{16}$ "
BULB (See page 42, Fig. 10)		S-17
BASE		Medium 4-Pin

* This rating is permissible only with filter circuits having an input choke of at least 20 henries.

INSTALLATION

The base pins of the '80 fit the standard four-contact socket which should be mounted preferably to hold the tube in a vertical position. If it is necessary to place the tube in a horizontal position, the socket should be mounted with both of the filament pin openings, either at the top or at the bottom. This precaution locates the filament plane vertical for most satisfactory performance. For socket connections, see page 39, Fig. 2. Provision should be made for free circulation of air around the bulb since it becomes quite hot during operation.

The coated filament of the '80 is designed to operate from the a-c line through a step-down transformer. The voltage applied to the filament terminals should be the rated value of 5.0 volts under operating conditions and average line voltage.

The approximate d-c output voltage of the '80 for various values of a-c input voltages may be obtained from the curves. For the d-c voltage available at the radio set, it is necessary to subtract the voltage drop across the filter from the value read from the curves.

The filter may be of either the condenser-input or choke-input type. If an input condenser is used, consideration must be given to the instantaneous peak value of the a-c input voltage. The peak value is about 1.4 times the RMS value as measured by most a-c voltmeters. Filter condensers, therefore, especially the input condenser, should have a rating high enough to withstand the instantaneous peak value, if breakdown is to be avoided. When the input-choke method is used, the available d-c output voltage will be somewhat lower than with the input-condenser method for a given a-c plate voltage. However, improved regulation together with lower peak current will be obtained.

APPLICATION

As a full-wave rectifier, the '80 may be operated with condenser-input or choke-input filter under conditions not to exceed the ratings given under CHARACTERISTICS.

As a half-wave rectifier, two '80's may be operated in a full-wave circuit with reasonable serviceability to deliver more d-c output current than can be obtained from one tube. For this use, the plates of each '80 are tied together at the socket. The allowable voltage and load conditions per tube are the same as for full-wave service.

THE RCA RADIOTRON MANUAL

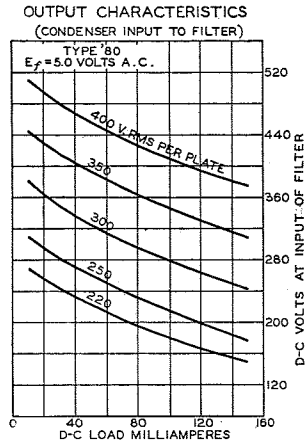
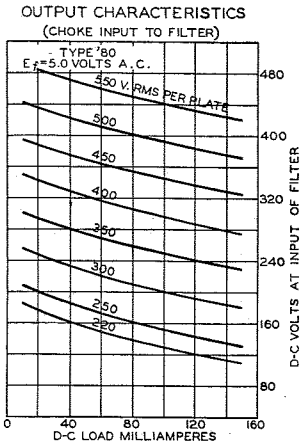

TYPICAL FULL-WAVE RECTIFIER CIRCUIT

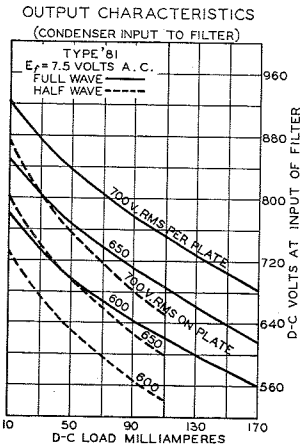
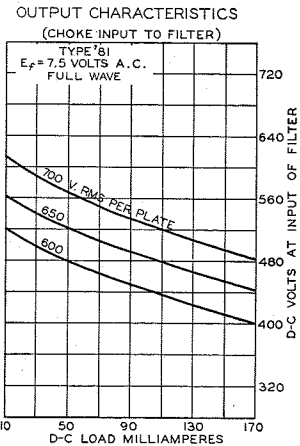
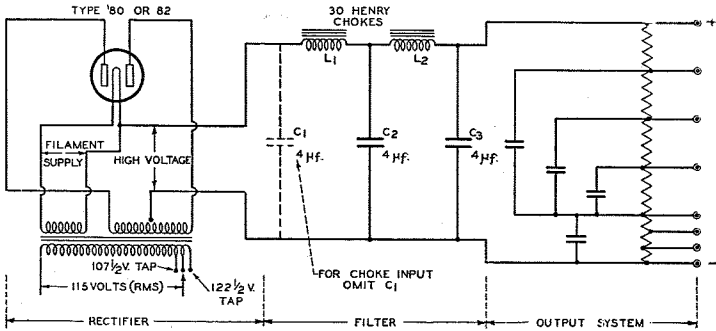

RCA Radiotron

UX-281

HALF-WAVE RECTIFIER

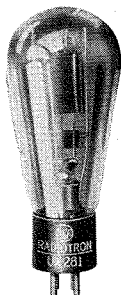

The '81 is a half-wave rectifier tube for use in d-c socket-power devices operating from the alternating current supply line. Full-wave rectification may be accomplished by two '81's.

CHARACTERISTICS

FILAMENT VOLTAGE (A. C.)	7.5	Volts
FILAMENT CURRENT	1.25	Amperes
A-C PLATE VOLTAGE (RMS)	700 max.	Volts
D-C OUTPUT CURRENT	85 max.	Milliamperes
MAXIMUM OVERALL LENGTH		6 $\frac{1}{4}$ "
MAXIMUM DIAMETER		2 $\frac{7}{16}$ "
BULB (See page 42, Fig. 12)		S-19
BASE		Medium 4-Pin

INSTALLATION

The base pins of the '81 fit the standard four-contact socket which should be mounted to hold the tube in a vertical position. For socket connections, see page 39, Fig. 3. Provision should be made for free circulation of air around the bulb since it becomes quite hot during operation.

The coated **filament** of the '81 is designed to operate from the a-c line through a step-down transformer. The voltage applied to the filament terminals should be the rated value of 7.5 volts under operating conditions and average line voltage.

The approximate **d-c output voltage** of the '81 in half-wave and full-wave connection for various values of a-c input voltages may be obtained from the curves. For the d-c voltage available at the radio set, it is necessary to subtract the voltage drop across the filter from the value read from the curves on preceding page.

The **filter** may be of either the condenser-input or choke-input type. If an input condenser is used, consideration must be given to the instantaneous peak value of the a-c input voltage. The peak value is about 1.4 times the RMS value as measured by most a-c voltmeters. For this reason, filter condensers, especially the input condenser, should have a rating high enough to withstand the instantaneous peak value, if breakdown is to be avoided. When the input-choke method is used, the available d-c output voltage will be somewhat lower than with the input-condenser method for a given a-c plate voltage. However, improved regulation, together with lower peak current, will be obtained.

APPLICATION

As a **half-wave rectifier**, the '81 may be operated under conditions not to exceed those given under CHARACTERISTICS.

In **full-wave** circuits, two '81's are required to rectify each half of the a-c voltage. Operating voltages per tube are the same as for the half-wave circuit, but twice the d-c output current may be obtained.

For **special applications**, it is possible to obtain a d-c output voltage approximately double that to be expected from conventional rectifier circuits, without exceeding the recommended maximum a-c input voltage per tube. This is accomplished by means of a voltage doubling system designed for each particular application.

RCA Radiotron

RCA-82

FULL-WAVE MERCURY-VAPOR RECTIFIER



The 82 is a full-wave mercury-vapor rectifier tube of the hot-cathode type for use in suitable rectifying devices designed to supply d-c power of uniform voltage to receivers in which the direct current requirements are subject to considerable variation.

The excellent voltage regulation characteristic of the 82 is due to its low and practically constant voltage drop (only about 15 volts) for any current drain up to the full emission of the filament (see page 4). The 82 is not interchangeable with any other rectifier type.

CHARACTERISTICS

FILAMENT VOLTAGE (A. C.)	2.5	Volts
FILAMENT CURRENT	3.0	Amperes
MAXIMUM A-C VOLTAGE PER PLATE (RMS)	500	Volts
MAXIMUM PEAK INVERSE VOLTAGE.....	1400	Volts
MAXIMUM D-C OUTPUT CURRENT, Continuous....	125	Milliamperes
MAXIMUM PEAK PLATE CURRENT	400	Milliamperes
TUBE VOLTAGE DROP, Approximate.....	15	Volts
MAXIMUM OVERALL LENGTH		4 $\frac{1}{16}$ "
MAXIMUM DIAMETER		1 $\frac{13}{16}$ "
BULB (See page 42, Fig. 8)		S-14
BASE		Medium 4-Pin

MERCURY-VAPOR RECTIFIER CONSIDERATIONS

The 82 has very low internal resistance, so that the current it delivers depends on the resistance of the load and the regulation of the power transformer. Sufficient protective resistance or reactance must always be used with this tube to limit its current to the recommended maximum value. If this value is exceeded, the tube voltage drop will increase rapidly and may permanently damage the filaments.

It is characteristic of mercury-vapor rectifiers that no appreciable plate current will flow until the plate voltage reaches a certain critical positive value. At this point the plate current rises steeply to a high value in a small fraction of a second. This surge of current re-occurring each time either plate becomes positive may excite circuits in the vicinity of the tube to damped oscillation and thus cause noisy radio receiver operation. It is usually necessary, therefore, to provide small radio-frequency chokes in series with each plate lead so that the slope of the current wave front to the filter is reduced sufficiently to eliminate impact excitation.

INSTALLATION

The base of the 82 is of the medium 4-pin type. Its pins fit the standard four-contact socket which should be installed to operate the tube in a vertical position with the base down. Only a socket making very good filament contact and capable of carrying 3 amperes continuously should be used. Poor contact at the filament pins will cause overheating at the pins and socket, lowered filament voltage, and also high internal tube drop with consequent injury to the tube. For socket connections, see page 39, Fig. 2.

THE RCA RADIOTRON MANUAL

The **bulb** becomes hot during continuous operation. Provision should be made, especially if shielding is employed, for adequate natural ventilation to prevent overheating.

The **filament** is of the coated type and is intended for a-c operation from one of the secondary windings of a power transformer. This winding, provided with a center-tap or center-tap-resistor, should supply at the filament terminals the rated operating voltage of 2.5 volts when average rated voltage is applied to the primary. The high current taken by the filament and the possibility of damage caused by applying plate voltage to the tube with its filament insufficiently heated make it imperative that all connections in the filament circuit be of low resistance and of adequate current-carrying capacity.

The **plate supply** is obtained from a center-tapped high voltage winding designed so that the maximum a-c input voltage per plate will not exceed 500 volts RMS under varying conditions of supply line voltage. The resistance of the transformer windings should, of course, be low if full advantage of the excellent regulation capabilities of this mercury-vapor rectifier is to be obtained. Since the drop through the tube is practically constant, any reduction in rectified voltage when the load is increased is due to the drop in the transformer and/or the filter windings. The return lead from the plates, i.e., the positive bus of the filter and load circuit, should be connected to the center-tap of the filament winding.

Shielding of this tube, particularly in sensitive receivers, may be necessary to eliminate objectionable noise. Radio-frequency choke coils, connected in series with each plate lead and placed within the shielding if used, are usually necessary in receivers having high sensitivity. The inductance of the chokes should be one millihenry or more.

A **fuse** having a rating approximately 50% in excess of normal load requirements should be inserted in the primary of the power transformer to prevent damage in case of excessive current which may flow under abnormal conditions.

It is recommended that the entire equipment be disconnected from the a-c power supply whenever the 82 is removed from or installed in its socket.

APPLICATION

The 82 is recommended for supplying d-c power to receivers, particularly those employing Class B audio amplification (see page 15). The direct current requirements of such receivers cause considerable variation in the load impressed on the rectifier tube. The 82 is especially suited to take care of this load demand with excellent regulation.

Filter circuits of either the condenser-input or the choke-input type may be employed provided that the maximum voltages and currents tabulated under CHARACTERISTICS are not exceeded. If the condenser-input type of filter is used, consideration must be given to the instantaneous peak value of the a-c input voltage which is about 1.4 times the RMS value measured from plate to filament with an a-c voltmeter. It is important, therefore, that the filter condensers (especially the input one) have a sufficiently high break-down rating to withstand this instantaneous peak value. It should be noted that with condenser input to the filter, the peak plate current of the tube is considerably higher than the load current. With a large condenser in the filter circuit next to the rectifier tube, the peak current is often as much as four times the load current. When, however, choke input to the filter is used, the peak plate current is considerably reduced. This type of circuit, therefore, is to be preferred from the standpoint of obtaining the maximum continuous d-c output current from the 82 under the most favorable conditions.

Under operating conditions, the 82 has a bluish-white glow filling the space within the plates and extending to some degree into the surrounding space outside the plates. This glow, caused by the mercury vapor, is an inherent operating characteristic of the 82.

RCA Radiotron

UV-199 AND UX-199

DETECTORS, AMPLIFIERS

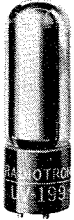

The '99 types are three-electrode, general purpose tubes designed for dry-cell operation. The low power consumption of these tubes makes them applicable to portable receivers and services where power economy is important. The two types have different bases.

CHARACTERISTICS

FILAMENT VOLTAGE (D. C.)	3.0-3.3	Volts
FILAMENT CURRENT	0.060-0.063	Ampere
PLATE VOLTAGE	90 <i>max.</i>	Volts
GRID VOLTAGE	-4.5	Volts
PLATE CURRENT	2.5	Milliamperes
PLATE RESISTANCE	15500	Ohms
AMPLIFICATION FACTOR	6.6	
MUTUAL CONDUCTANCE	425	Micromhos
GRID-PLATE CAPACITANCE	3.3	μ f.
GRID-FILAMENT CAPACITANCE	2.5	μ f.
PLATE-FILAMENT CAPACITANCE	2.5	μ f.
	Type '99	X-Type '99
MAXIMUM OVERALL LENGTH	3 1/2"	4 1/8"
MAXIMUM DIAMETER	1 1/16"	1 3/16"
BULB (See Figs. on page 42)	T-8 (Fig. 3)	T-8 (Fig. 1)
BASE	Small 4-Nub	Small 4-Pin

INSTALLATION

The base pins of the X-Type '99 fit the standard four-contact socket while the '99 fits only the small shell socket with bayonet slot. The socket should be installed so that the tubes will operate in a vertical position. Cushioning of the socket in the detector stage may be desirable if microphonic disturbances are encountered. For socket connections of X-Type '99 and of '99, see page 39, Fig. 1 and Fig. 10, respectively.

The filaments in these tubes are designed for operation with three No. 6 dry-cells connected in series. In multi-tube receivers the use of six or nine No. 6 dry-cells connected in series-parallel to give 4.5 volts will decrease the current drain per cell and give a more stable source of filament power. If storage-battery operation is preferred, a four-volt storage battery may be used. In any case, a filament rheostat should be provided so that the filament voltage can be adjusted to the recommended operating value.

APPLICATION

As detectors, '99's may be operated either with grid leak and condenser or with grid bias. The recommended plate voltage for the former method is 45 volts. A grid leak of from 1 to 5 megohms used with a grid condenser of 0.00025 μ f. is satisfactory. The grid circuit return should be connected to the positive filament terminal. For grid bias detection the maximum plate voltage of 90 volts may be used with the corresponding negative grid bias of 10.5 volts. The grid bias should be adjusted so that the plate current is 0.2 milliamperes with no a-c input signal.

As amplifiers, '99's are applicable to the audio- or the radio-frequency stages of a receiver. Recommended plate and grid voltages are shown under CHARACTERISTICS.

RCA RADIOTRONS

For

AMATEUR AND EXPERIMENTAL RADIO USES

Radiotron UX-841 is a 3-electrode high mu, voltage amplifier tube, designed primarily for use in resistance-coupled circuits. It is also useful in amateur transmitters as a crystal-controlled oscillator, and as a radio-frequency doubler and amplifier. Filament volts 7.5. Power output (Class C) 10 watts.

Radiotron RCA-852 is a 3-electrode 100 watt transmitting tube designed for use as an oscillator and r-f power amplifier, particularly at frequencies above 3000 kc. Filament volts 10. Normal plate volts 2000.

Radiotron RCA-864 is a 3-electrode tube of the general purpose receiving type especially desirable in services where freedom from microphonic disturbance is required. Filament volts 1.1 D.C. Maximum plate volts 135.

Radiotron RCA-865 is a 12.5 watt screen-grid, low-power transmitting tube for use as a radio-frequency amplifier especially for frequencies above 3000 kc. It is also very useful as a crystal-controlled oscillator. Filament volts 7.5. Maximum plate volts 500.

Radiotron RCA-866 is a high-voltage half-wave rectifier tube of the hot-cathode mercury-vapor type. Its large d-c current capacity and its low tube voltage drop make it ideal as a rectifier for the medium-power amateur transmitter. Filament volts 2.5. Maximum peak inverse volts 7500. Maximum peak plate current 600 ma.

Radiotron RCA-868 is a sensitive phototube of the gaseous type. It is particularly well adapted for use with sound moving pictures in the home and for experiments with light because of its excellent response to incandescent lamp sources of light.

Radiotron RCA-210 is well adapted to transmitting circuits as an oscillator, a-f power amplifier and as a r-f amplifier and frequency doubler. Filament volts 7.5. Power output (Class C) 10 watts.

Radiotron UX-250 is recommended for use as a modulator and amplifier in low power radio telephone transmitters. Filament volts 7.5. Maximum plate volts 450.

For additional information on these types, write to the Commercial Engineering Section, RCA Radiotron Co., Inc., Harrison, N. J.



RCA RADIOTRONS

For

AMATEUR AND EXPERIMENTAL RADIO USES

Radiotron UX-841 is a 3-electrode high mu, voltage amplifier tube, designed primarily for use in resistance-coupled circuits. It is also useful in amateur transmitters as a crystal-controlled oscillator, and as a radio-frequency doubler and amplifier. Filament volts 7.5. Power output (Class C) 10 watts.

Radiotron RCA-852 is a 3-electrode 100 watt transmitting tube designed for use as an oscillator and r-f power amplifier, particularly at frequencies above 3000 kc. Filament volts 10. Normal plate volts 2000.

Radiotron RCA-864 is a 3-electrode tube of the general purpose receiving type especially desirable in services where freedom from microphonic disturbance is required. Filament volts 1.1 D.C. Maximum plate volts 135.

Radiotron RCA-865 is a 12.5 watt screen-grid, low-power transmitting tube for use as a radio-frequency amplifier especially for frequencies above 3000 kc. It is also very useful as a crystal-controlled oscillator. Filament volts 7.5. Maximum plate volts 500.

Radiotron RCA-866 is a high-voltage half-wave rectifier tube of the hot-cathode mercury-vapor type. Its large d-c current capacity and its low tube voltage drop make it ideal as a rectifier for the medium-power amateur transmitter. Filament volts 2.5. Maximum peak inverse volts 7500. Maximum peak plate current 600 ma.

Radiotron RCA-868 is a sensitive phototube of the gaseous type. It is particularly well adapted for use with sound moving pictures in the home and for experiments with light because of its excellent response to incandescent lamp sources of light.

Radiotron RCA-210 is well adapted to transmitting circuits as an oscillator, a-f power amplifier and as a r-f amplifier and frequency doubler. Filament volts 7.5. Power output (Class C) 10 watts.

Radiotron UX-250 is recommended for use as a modulator and amplifier in low power radio telephone transmitters. Filament volts 7.5. Maximum plate volts 450.

For additional information on these types, write to the Commercial Engineering Section, RCA Radiotron Co., Inc., Harrison, N. J.



RCA Radiotron

RCA-41

Power Amplifier Pentode
6.3 Volt Heater

The 41 is a power amplifier pentode of the heater-cathode type for use in the audio output stage of radio receivers, especially those of the mobile type which obtain their heater-supply voltage from a storage battery. The tube is capable of giving a large power output with a relatively small input signal voltage.

This tube is characterized physically by the small overall size, the dome-top bulb and the rigidity of the electrode assembly. The heater-cathode design permits uniform tube operation over a comparatively wide range of heater voltages without appreciably affecting the performance or serviceability of the tube.

In comparison with other types for the output stage of automobile receivers, the 41 has greater power output capability than the '38 and has the same output as the 89 with the pentode connection. The 41 has higher power sensitivity than the 89 but lacks the 89's flexibility of application to Class A and to Class B Triode amplifier circuits. These three types are not interchangeable.

Tentative Characteristics

HEATER VOLTAGE (A.C. or D.C.)			6.3	Volts
HEATER CURRENT			0.4	Ampere
PLATE VOLTAGE	125	167.5	180	max. Volts
SCREEN VOLTAGE	125	167.5	180	max. Volts
GRID VOLTAGE	-10	-12.5	-13.5	Volts
PLATE CURRENT	11	17	18.5	Milliamp.
SCREEN CURRENT	2	3	3	Milliamp.
PLATE RESISTANCE	100000	85000	81000	Ohms
AMPLIFICATION FACTOR	150	150	150	
MUTUAL CONDUCTANCE	1525	1800	1850	Micromhos
LOAD RESISTANCE	11000	9500	9000	Ohms
POWER OUTPUT (10% total distortion)	650	1250	1500	Milliwatts
MAXIMUM OVERALL LENGTH				4-1/4"
MAXIMUM DIAMETER				1-9/16"
BULB				ST-12
BASE				Medium 6-Pin

Installation

The base pins of the 41 fit the standard six-contact socket which may be installed to hold the tube either in a vertical or in a horizontal position. For horizontal operation, the socket should be positioned with the heater-pin openings one vertically above the other. For socket connections, see page 2.

The bulb of this tube will become very hot under certain conditions of operation. Sufficient ventilation, therefore, should be

provided to circulate air freely around the tube to prevent overheating.

The heater of the 41 is designed to operate directly from a 6-volt automobile storage battery despite the voltage fluctuations during the charge and discharge periods. If the heater is operated with a.c., the transformer winding which supplies the heater circuit should be designed to operate the heater at 6.3 volts for full-load operating conditions at average line voltage.

Application

For the *power amplifier* stage of automobile receivers and other receivers where the available high-voltage supply is limited to 180 volts, the 41 may be used either singly or in push-pull combination. More than one audio stage preceding the 41 is undesirable because of the possibility of microphonic disturbances resulting from the high level of amplification.

If a single 41 is operated self-biased at 167.5 or 180 volts on the plate and screen, the self-biasing resistor should have a value of 630 ohms. This resistor should be shunted by a suitable filter network to avoid degenerative effects at low audio frequencies. The use of two 41's in push-pull eliminates the necessity for shunting the resistor. The self-biasing resistor required for the push-pull stage is one-half that for a single stage.

Any conventional type of *input coupling* may be used provided the resistance added to the grid circuit by this device is not too high. Transformer or impedance coupling devices are recommended. If, however, resistance coupling is employed, the grid resistor should not exceed 250000 ohms with self-bias. When self-bias is not used, the value should be limited to 100000 ohms.

An *output transformer* should be used to supply power to the winding of the reproducing unit. The optimum value of load resistance for a single tube is given under TENTATIVE CHARACTERISTICS. For push-pull operation, the plate-to-plate load resistance should be twice that for a single tube. For best results, the impedance in the plate circuit of the 41 should be as uniform as possible over the entire audio-frequency range.

Tube Symbol and Top View of Socket Connections

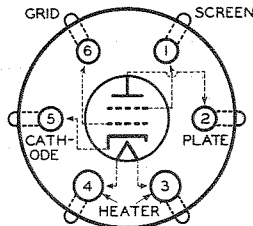

RCA Radiotron

RCA-48

POWER AMPLIFIER TETRODE

30 Volt D-C Heater

The 48 is a power amplifier tetrode which has pentode characteristics when operated at the recommended screen and plate voltage. It is for use in the audio-output stage of receivers designed to operate from 115 volt d-c power lines. The 48 is exceptional in its ability to deliver power at the low plate and screen voltage obtainable in such service. Two 48's in a push-pull amplifier circuit are capable of supplying several times more power than any tube hitherto available for such service.

The large power-delivering ability of the 48 is made practical by the unique features of its electrical and structural design. Among these are the big cathode with its large emitting surface, the control-grid structure with its heat radiator, and the plate with a rib structure fastened to its inner surface. The rib structure serves to suppress the effects of secondary emission which limit the power output of four-electrode screen-grid types.

The heater of the 48 is designed for series operation at 30 volts d.c. It is possible, therefore, to operate the heaters of two of these tubes in series with the heaters of 6.3 volt types with a minimum of auxiliary resistance in the heater circuit, and with consequent reduction of heat-energy to be dissipated in the receiver.

CHARACTERISTICS

HEATER VOLTAGE (D.C.)		30.0	Volts
HEATER CURRENT		0.4	Ampere
PLATE VOLTAGE	95	125*	max. Volts
SCREEN VOLTAGE	95	100	max. Volts
GRID VOLTAGE	-20	-22.5*	Volts
PLATE CURRENT	47	50	Milliamperes
SCREEN CURRENT	9	9	Milliamperes
PLATE RESISTANCE (Approx.)	10000	10000	Ohms
AMPLIFICATION FACTOR (Approx.)	28	28	
MUTUAL CONDUCTANCE	2800	2800	Micromhos
LOAD RESISTANCE	2000	2000	Ohms
POWER OUTPUT**	1600	2500	Milliwatts
MAXIMUM OVERALL LENGTH		5-3/8"	
MAXIMUM DIAMETER		2-1/16"	
BULB		ST-12	
BASE		Medium 6-Pin	

* Recommended conditions for operation with auxiliary C-battery which permits utilization of full d-c power line voltage (110-125 v.) for plate supply.

**9% total harmonic distortion.

INSTALLATION

The *base* of the 48 fits the standard six-contact socket which may be installed to operate the tube either in a vertical or in a horizontal position. For horizontal operation, the socket should be positioned with the plate pin opening at the top and the cathode pin opening at the bottom or vice versa. For socket connections, see page 3.

The *bulb* of this tube may become very hot under certain conditions of operation. Sufficient ventilation, therefore, should be provided around the tube to prevent overheating.

The *heater* of the 48 is designed to operate at approximately 30 volts. Due to the heater-cathode design, the heater voltage may range between 26 and 34 volts during line voltage fluctuations without greatly affecting the performance or serviceability of the tube.

In a series-heater circuit employing several 6.3 volt types and one or more 48's, the heaters of the 48's should be placed on the positive side. Furthermore, since the 6.3 volt types have 0.3 ampere heaters, a bleeder circuit across these heaters is required to take care of the additional 0.1 ampere heater current of the 48. Each 6.3 volt tube in the series circuit should, therefore, be shunted by a bleeder resistance of 63 ohms.

The *cathode* circuit in most d-c receivers is usually tied in either directly or through biasing resistors (or C-battery) to the negative side of the heater circuit. The potential difference thus introduced between heater and cathode of the 48 should not exceed 90 volts, as measured between the negative heater terminal and the cathode.

APPLICATION

As a *power amplifier* in the output stage of d-c line receivers, the 48 is recommended for use either singly or in push-pull combination. Recommended operating conditions are given under CHARACTERISTICS.

When a single 48 is operated self-biased, the self-biasing resistor should be approximately 360 ohms. This resistor should be shunted by a suitable filter network to avoid degeneration effects at low audio frequencies. With two 48's in push-pull, the network may be omitted. The self-biasing resistor required for the push-pull stage is approximately 180 ohms.

Any conventional type of *input coupling* may be used provided the resistance added to the grid circuit by this device is not too high. Transformer or impedance coupling devices are preferable. In any case, the sum of the resistance of the coupling devices in the grid circuit and the resistance of the filter network (if used) should not exceed 10000 ohms.

An *output transformer* should be used in order to supply power to the winding of the reproducing unit. The optimum value of load resistance for a single tube is 2000 ohms. For push-pull operation, the plate-to-plate load resistance should be 4000 ohms. For best results, the impedance in the plate circuit of the 48 should be as uniform as possible over the entire audio-frequency range, as in the case of power amplifier pentodes.

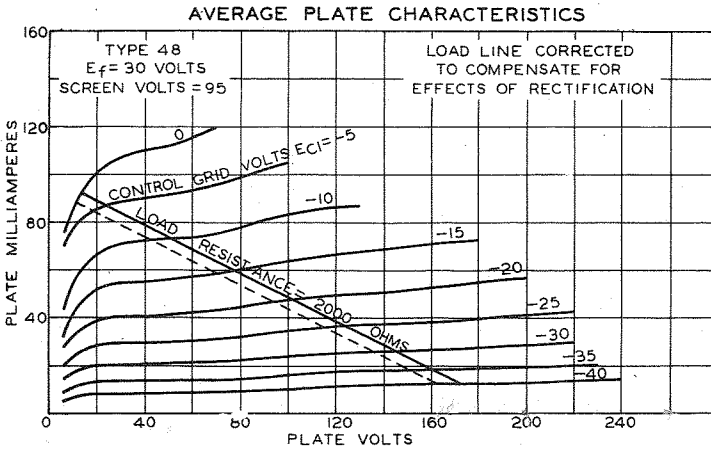

Tube Symbol and Top View of Socket Connections

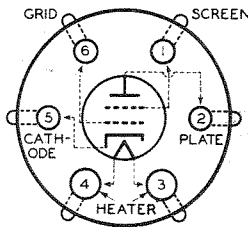

RCA Radiotron

RCA-59

Triple-Grid Power Amplifier 2.5 Volt Heater

The 59 is a triple-grid power amplifier tube of the heater-cathode type recommended for use in the output stage of a-c operated receivers. The triple-grid construction of this tube, with external connections for each grid, makes possible its application as (1) a Class A Power Amplifier Triode, (2) a Class A Power Output Pentode, and (3) a Class B Power Output Triode.

The 59 is characterized physically by the dome-top bulb, the rigidity of electrode assembly, and the separate terminals for each electrode.

TENTATIVE CHARACTERISTICS

HEATER VOLTAGE (A.C. or D.C.)	2.5	Volts
HEATER CURRENT	2.0	Amperes
MAXIMUM OVERALL LENGTH	5-3/8"	
MAXIMUM DIAMETER	2-1/16"	
BULB	ST-16	
BASE	Medium 7-Pin	

Triode Connection - Class "A" Power Amplifier

(Grids #2 and #3 tied to plate; grid #1 is control-grid)

HEATER VOLTAGE	2.5	Volts
PLATE VOLTAGE	250 max.	Volts
GRID VOLTAGE (Grid #1)	-28	Volts
AMPLIFICATION FACTOR	6.0	
PLATE RESISTANCE	2400	Ohms
MUTUAL CONDUCTANCE	2600	Micromhos
PLATE CURRENT	26	Milliamperes
LOAD RESISTANCE (Optimum for Maximum U.P.O.)*	5000	Ohms
UNDISTORTED POWER OUTPUT (5% 2nd Harmonic)	1250	Milliwatts

Pentode Connection - Class "A" Power Amplifier

(Grid #3 tied to cathode; grid #2 is screen; grid #1 is control-grid)

HEATER VOLTAGE	2.5	Volts
PLATE VOLTAGE	250 max.	Volts
SCREEN VOLTAGE (Grid #2)	250 max.	Volts
GRID VOLTAGE (Grid #1)	-18	Volts
AMPLIFICATION FACTOR	100	
PLATE RESISTANCE	40000	Ohms
MUTUAL CONDUCTANCE	2500	Micromhos
PLATE CURRENT	35	Milliamperes
SCREEN CURRENT	9	Milliamperes
LOAD RESISTANCE**	6000	Ohms
POWER OUTPUT (7% Total Distortion)	3.0	Watts

*Approx. twice this value is recommended for load of driver for Class B stage.

**A load resistance of 7000 ohms will give the same power output as 6000 ohms but with 20% greater distortion.

Triode Connection - Class "B" Power Amplifier

(Grid #3 tied to plate; grids #1 and #2 connected together)

PLATE VOLTAGE		400	max.	Volts
DYNAMIC PEAK PLATE CURRENT		200	max.	Milliamp.
AVERAGE PLATE DISSIPATION		10	max.	Watts
AVERAGE GRID DISSIPATION (Grids #1 and #2 together)		1.5	max.	Watts
TYPICAL OPERATION (2 Tubes):				
Heater Voltage		2.5		Volts
Plate Voltage	300	400	max.	Volts
Grid Voltage (grids#1 and #2 together)	0	0		Volts
Static Plate Current (per tube)	10	13		Milliamp.
Load Resistance (plate to plate)	4600	6000		Ohms
Nominal Power Output (2 tubes)	15	20		Watts

INSTALLATION

The *base* of the 59 is of the medium 7-pin type. Its pins fit the the standard seven-contact socket which may be installed to operate the tube either in a vertical or in a horizontal position. For horizontal operation, the socket should be positioned with the heater pin openings one vertically above the other. For socket connections see page 4.

The *bulb* of this tube may become very hot under certain conditions of operation. Sufficient ventilation, therefore, should be provided to circulate air freely around the tube to prevent overheating.

The *heater* of the 59 is designed for a-c operation at 2.5 volts. The transformer winding supplying the heater circuit should be designed to operate the heater at this recommended value for full-load operating conditions at average line voltage.

The *cathode* should preferably be connected directly to a mid-tap on the heater winding. If this practice is not followed, the potential difference between heater and cathode should be limited to 45 volts.

The *grids* for any particular type of amplifier service should be connected as indicated under APPLICATION.

APPLICATION

For *Class A Triode Operation of the 59*, the two grids (#3 and #2) immediately adjacent to the plate are connected to the plate, while the third (#1) is employed for control purposes. Operation of the tube is then similar to any Class A power amplifier triode. The tabulated values for Class A operation of this type as given under CHARACTERISTICS, are for its operation as a power output tube. When

it is used as the driver for a Class B stage, the load requirements are changed, as indicated in the note under CHARACTERISTICS. This change is recommended in order to minimize distortion due to the driver stage.

The d-c resistance in the grid circuit of the 59 operating as a Class A amplifier (either with triode or pentode connection) should not exceed 0.5 megohm if self-bias is used. Without self-bias, the resistance should not exceed 10000 ohms. The use of resistances higher than these may cause the tube to lose bias due to grid current with the result that the plate current will rise to a value sufficiently high to damage the tube.

For *Class A Pentode Operation* of the 59, the grid (#3) adjacent to the plate is tied to the cathode and thus serves as the suppressor, while the other two grids (#2 and #1) serve as the screen-grid and control-grid respectively. Operation of the tube is then similar to any Class A power output pentode. Refer to CHARACTERISTICS for operating voltages.

For *Class B Triode Operation* of the 59, the grid (#3) adjacent to the plate is tied to the plate, while the other grids (#2 and #1) are connected together to serve as a single control-grid. No grid bias is necessary with this connection. This feature is particularly important because it prevents the variation of bias with applied signal which would otherwise exist if any self-bias arrangement were employed.

The direct-current requirements of Class B circuits are subject to fluctuation under operating conditions. The power supply, therefore, should have as good regulation as possible to maintain proper operating voltages regardless of the current drain. For this purpose a suitably designed B-eliminator may be employed. A rectifier tube of the mercury-vapor type is recommended because of its low and practically constant space-charge-voltage drop within its operating range.

The grid (#1 and #2) of the 59 is operated sufficiently positive to cause grid current to flow in its input circuit. This feature imposes a further requirement on the preceding amplifier stage. It must supply not only the necessary input voltage, but it must be capable of doing so under conditions where appreciable power is taken by the grid of the Class B amplifier tube. The design of a Class B audio amplifier with its driver stage is, therefore, somewhat more involved than for a Class A system and must be checked for each change in the component parts.

In the design of Class B Amplifiers, the interstage transformer is the link interconnecting the driver and the Class B stage. It is usually of the step-down type, that is, the primary input voltage is higher than the secondary voltage supplied to the grids of the power output tubes. Depending upon conditions, the ratio of the interstage transformer primary to one-half its secondary may range be-

tween 1.5/1 and 5.5/1. The transformer step-down ratio is dependent on the following factors: (1) Type of driver tube, (2) type of power tube, (3) load on power tube, (4) permissible distortion, (5) transformer efficiency (peak power). The primary impedance of the interstage transformer should be essentially the same as if the transformer were to be operated with no load, that is, into an open grid. Since power is transferred, the transformer should have reasonable power efficiency.

The type of driver tube chosen should be capable of handling sufficient power to operate the Class B amplifier stage. Allowance should be made for transformer efficiency. It is most important, if low distortion is desired, that the driver tube be worked into a load resistance higher than the normal value for optimum power output as a Class A power amplifier, since distortion produced by the driver stage and the power-output stage will be present in the output.

Tube Symbol and Top View of Socket Connections.

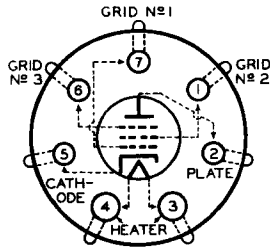

RCA Radiotron

RCA-83

Full-Wave Mercury-Vapor Rectifier Heavy-Duty

The 83 is a *heavy-duty*, full-wave, mercury-vapor rectifier tube of the hot-cathode type. It is intended for use in suitable rectifying devices designed to supply d-c power of uniform voltage to receivers, the direct current requirements of which are subject to considerable variation and are in excess of the rating of the 82. The excellent voltage regulation characteristic of the 83 is due to its low and practically constant voltage drop (only about 15 volts) for any current drain up to the full emission of its filaments. *The 83 is not recommended for interchange with any other rectifier type.*

Mercury-Vapor Rectifier Considerations

The 83 has very low internal resistance so that the current it delivers depends on the resistance of the load and the regulation of the power transformer. Sufficient protective resistance or reactance must always be used with this tube to limit its current to the recommended maximum value. If this value is exceeded, the tube voltage drop will increase rapidly and may permanently damage the filaments.

It is characteristic of mercury-vapor rectifiers that no appreciable plate current will flow until the plate voltage reaches a certain critical positive value. At this point the plate current rises steeply to a high value in a small fraction of a second. This surge of current reoccurring each time either plate becomes positive, may excite circuits in the vicinity of the tube to damped oscillation and may result in noisy receiver operation. It is usually necessary, therefore, to connect small radio-frequency chokes in series with each plate lead so that the slope of the current wave front to the filter is reduced sufficiently to eliminate impact excitation.

TENTATIVE CHARACTERISTICS

FILAMENT VOLTAGE (A.C.)	5.0	Volts
FILAMENT CURRENT	3.0	Amperes
A-C VOLTAGE PER PLATE (RMS)	500 <i>max.</i>	Volts
PEAK INVERSE VOLTAGE	1400 <i>max.</i>	Volts
D-C OUTPUT CURRENT (Continuous)	250 <i>max.</i>	Milliamperes
PEAK PLATE CURRENT	800 <i>max.</i>	Milliamperes
TUBE VOLTAGE DROP (Approximate)	15	Volts
MAXIMUM OVERALL LENGTH		5-3/8"
MAXIMUM DIAMETER		2-1/16"
BULB		ST-16
BASE		Medium 4-Pin

INSTALLATION

The *base* of the 83 is of the medium 4-pin type. Its pins fit the standard four-contact socket which should be installed to operate the tube in a vertical position with the base down. For socket connections, see page 3. Only a socket making very good filament contact and capable of carrying 3 amperes continuously should be used with the 83. Unless this precaution is followed, poor contact at the filament pins will cause overheating at the pins and socket, lowered filament voltage, and high internal tube drop with consequent injury to the tube.

The *bulb* becomes hot during continuous operation. Provision should be made for adequate natural ventilation to prevent overheating, especially in cases where shielding is employed.

The *filament* is of the coated type and is intended for a-c operation from one of the secondary windings of a power transformer. This winding, provided with a center-tap or center-tap resistor, should supply at the filament terminals the rated operating voltage of 5.0 volts when average rated voltage is applied to the primary. The high current taken by the filament and the possibility of damage to the tube caused by applying plate voltage with its filament insufficiently heated, make it imperative that all connections in the filament circuit be of low resistance and of adequate current-carrying capacity.

The *plate supply* is obtained from a center-tapped high voltage winding designed so that the maximum a-c input voltage per plate will not exceed 500 volts RMS under varying conditions of supply line voltage. The resistance of the transformer windings should, of course, be low if full advantage of the excellent regulation capabilities of this mercury-vapor rectifier is to be obtained. Since the drop through the tube is practically constant, any reduction in rectified voltage when the load is increased is due to the drop in the transformer and/or the filter windings. The return lead from the plates, i.e., the positive bus of the filter and load circuit, should be connected to the center-tap of the filament winding.

A *fuse* having a rating approximately 50% in excess of normal load requirements should be inserted in the primary of the power transformer to prevent damage in case of excessive current which may flow under abnormal conditions.

Shielding of this tube, particularly in sensitive receivers, may be necessary to eliminate objectionable noise. Radio-frequency choke coils, connected in series with each plate lead and placed within the shielding, if used, are usually necessary in receivers having high sensitivity. The inductance of the chokes should be one millihenry or more.

It is recommended that the entire equipment be disconnected from the a-c power supply whenever the 83 is removed from or installed in its socket.

APPLICATION

The 83 is intended for supplying large amounts of d-c power to receivers whose requirements are in excess of the rating of the 82. The 83 is particularly recommended for heavy-drain receivers employing Class B audio amplification. The direct-current requirements of such receivers cause considerable variation in the load impressed on the rectifier tube. The 83 is especially suited to take care of this load demand with excellent regulation.

Filter circuits of either the condenser-input or the choke-input type may be employed provided that the maximum voltages and currents tabulated under CHARACTERISTICS are not exceeded. If the condenser-input type of filter is used, consideration must be given to the instantaneous peak value of the a-c input voltage which is about 1.4 times the RMS value measured from plate to filament with an a-c voltmeter. It is important, therefore, that the filter condensers (especially the input one) have a sufficiently high breakdown rating to withstand this instantaneous peak value. It should be noted that with condenser input to the filter, the peak plate current of the tube is considerably higher than the load current. With a large condenser in the filter circuit next to the rectifier tube, the peak current is often as much as four times the load current. When, however, choke input to the filter is used, the peak plate current is considerably reduced. This type of circuit, therefore, is to be preferred from the standpoint of obtaining the maximum continuous d-c output current from the 83 under the most favorable conditions.

Under operating conditions, the 83 has a bluish-white glow filling the space within the plates and extending to some degree into the surrounding space outside the plates. This glow, caused by the mercury-vapor, is an inherent operating characteristic of the tube.

Tube Symbol and Top View of Socket Connections

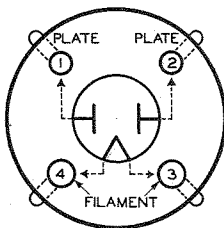

RCA Radiotron

RCA-89

TRIPLE-GRID POWER AMPLIFIER

6.3 Volt Heater

The 89 is a triple-grid power amplifier tube of the d-c heater-cathode type recommended especially for use in automobile receivers and other applications where d-c operation is desirable. The triple-grid construction of this tube, with external connections for each grid, makes possible its application as (1) a Class A Power Amplifier Triode, (2) a Class A Power Output Pentode, and (3) a Class B Power Output Triode.

The 89 is characterized physically by the small overall size, the dome-top bulb, the rigidity of electrode assembly, and the separate terminals for each electrode.

TENTATIVE CHARACTERISTICS

HEATER VOLTAGE	6.3	Volts
HEATER CURRENT	0.4	Ampere
OVERALL LENGTH	4-9/32" to 4-17/32"	
MAXIMUM DIAMETER	1-9/16"	
BULB	ST-12	
CAP	Small Metal	
BASE	Small 6-Pin	

Triode Connection - Class "A" Power Amplifier

(Grids #2 and #3 tied to plate; grid #1 is control-grid)

HEATER VOLTAGE	6.3	Volts
PLATE VOLTAGE (<i>max.</i> 180 volts)	160	Volts
GRID VOLTAGE (Grid #1)	-20	Volts
LOAD RESISTANCE (Optimum for Maximum U.P.O.)*	7000	Ohms
AMPLIFICATION FACTOR	4.7	
PLATE RESISTANCE	3000	Ohms
MUTUAL CONDUCTANCE	1570	Micromhos
PLATE CURRENT	17	Milliamp.
UNDISTORTED POWER OUTPUT (5% 2nd Harmonic)	300	Milliwatts

Pentode Connection - Class "A" Power Amplifier

(Grid #3 tied to cathode; grid #2 is screen; grid #1 is control-grid)

HEATER VOLTAGE	6.3	Volts
PLATE VOLTAGE	163	180 <i>max.</i> Volts
SCREEN VOLTAGE (Grid #2)	163	180 <i>max.</i> Volts
GRID VOLTAGE (Grid #1)	-17	Volts
LOAD RESISTANCE	9000	8000 Ohms
AMPLIFICATION FACTOR	125	135
PLATE RESISTANCE	79000	82500 Ohms
MUTUAL CONDUCTANCE	1575	1635 Micromhos
PLATE CURRENT	17	20 Milliamp.
SCREEN CURRENT	2.5	3.0 Milliamp.
POWER OUTPUT	1.25	1.5 Watts

* Approx. twice this value is recommended for load of driver for Class B stage.

Triode Connection - Class "B" Power Amplifier (Grid #3 tied to plate; grids #2 and #1 connected together)

PLATE VOLTAGE	180	max.	Volts
DYNAMIC PEAK PLATE CURRENT	75	max.	Milliamp.
AVERAGE GRID DISSIPATION (Grids #1 and #2 together)	0.35	max.	Watts
TYPICAL OPERATION (2 Tubes):			
Heater Voltage	6.3		Volts
Plate Voltage	180		Volts
Grid Voltage (grids #1 and #2 together)	0		Volts
Static Plate Current (per tube)	3		Milliamp.
Load Resistance (plate to plate)	9400		Ohms
Nominal Power Output (2 tubes)	3.5*		Watts

* Obtained with 89 driver used with triode connection as Class A power amplifier.

INSTALLATION

The *base* of the 89 is of the small 6-pin type. Its pins fit the standard six-contact socket which may be installed to operate the tube either in a vertical or in a horizontal position. For horizontal operation, the socket should be positioned with the filament pin openings one vertically above the other. For socket connections, see page 4.

The *bulb* of this tube may become very hot under certain conditions of operation. Sufficient ventilation, therefore, should be provided to circulate air freely around the tube to prevent overheating.

The *heater* of the 89 is designed to operate directly from a 6-volt automobile storage battery despite the voltage fluctuations during the charge and discharge periods.

The *cathode* circuit in most d-c receivers is usually tied in either directly or through biasing resistors to the negative side of the heater circuit. The potential difference thus introduced between heater and cathode should be kept as much as possible below the recommended maximum of 45 volts.

The *grids* for any particular type of amplifier service should be connected as indicated under APPLICATION.

APPLICATION

For *Class A Triode Operation* of the 89, the two grids (#3 and #2) immediately adjacent to the plate are connected to the plate, while the third (#1) is employed for control purposes. Operation of the tube is then similar to any Class A Power Amplifier Triode. The tabulated values for Class A operation of this type as given under

CHARACTERISTICS, are for its operation as a power output tube. When it is used as the driver for a Class B stage, the load requirements are changed as indicated in the note under CHARACTERISTICS. This change is recommended in order to minimize distortion due to the driver stage.

The d-c resistance in the grid circuit of the 89 operating as a Class A amplifier (either with triode or pentode connection) should not exceed 1.0 megohm if self-bias is used. Without self-bias, the resistance should not exceed 0.5 megohm. The use of resistances higher than these may cause the tube to lose bias due to grid current with the result that the plate current will rise to a value sufficiently high to damage the tube.

For *Class A Pentode Operation* of the 89, the grid (#3) adjacent to the plate is tied to the cathode and thus serves as the suppressor, while the other two grids (#2 and #1) serve as the screen-grid and control-grid respectively. Operation of the tube is then similar to any Class A power output pentode.

For *Class B Triode Operation* of the 89, the grid (#3) adjacent to the plate is tied to the plate, while the other two grids (#2 and #1) are connected together to serve as a single control-grid. No grid bias is necessary with this connection as the steady plate current at zero bias is only a few milliamperes. This feature is particularly important because it prevents the variation of bias with applied signal which would otherwise exist if any self-bias arrangement were employed.

The direct current requirements of Class B circuits are subject to fluctuation under operating conditions. The power supply, therefore, should have as good regulation as possible to maintain proper operating voltages regardless of the current drain. For this purpose, a high voltage B-battery or a suitably designed B-eliminator may be employed.

The grid (#1 and #2) of the 89 is operated sufficiently positive to cause grid current to flow in its input circuit. This feature imposes a further requirement on the preceding amplifier stage. It must supply not only the necessary input voltage, but it must be capable of doing so under conditions where appreciable power is taken by the grid of the Class B amplifier tube. The design of a Class B audio amplifier with its driver stage is, therefore, somewhat more involved than for a Class A system and must be checked for each change in the component parts.

In the design of Class B Amplifiers, the interstage transformer is the link interconnecting the driver and the Class B stage. It is usually of the step-down type, that is, the primary input voltage is higher than the secondary voltage supplied to the grids of the power output tubes. Depending upon conditions, the ratio of the interstage transformer primary to one-half its secondary may range between 1.5/1 and 5.5/1. The transformer step-down ratio is dependent on the following factors; (1) Type of driver tube (2) type of power

tube (3) load on power tube (4) permissible distortion (5) transformer efficiency (peak power). The primary impedance of the interstage transformer should be essentially the same as if the transformer were to be operated with no load, that is, into an open grid. Since power is transferred, the transformer should have reasonable power efficiency.

The type of driver tube chosen should be capable of handling sufficient power to operate the Class B amplifier stage. Allowance should be made for transformer efficiency. It is most important, if low distortion is desired, that the driver tube be worked substantially below its Class A undistorted output rating, since distortion produced by the driver stage and the power stage will be present in the output.

Tube Symbol and Top View of Socket Connections

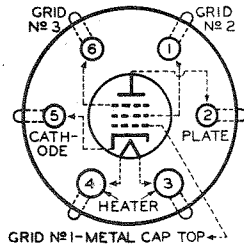

RCA RADIOTRON CHARACTERISTICS CHART

DETECTORS AND AMPLIFIERS

TYPE	PURPOSE	BASE	SOCKET CONNECTIONS <small>SEE MANUAL PAGE 39</small>	DIMENSIONS MAX. OVERALL		CATHODE TYPE	RATING			PLATE SUPPLY VOLTS	NEGATIVE GRID BIAS VOLTS		SCREEN VOLTS	PLATE CURR. MILLI-AMP.	SCREEN CURR. MILLI-AMP.	A C PLATE RESISTANCE OHMS	MUTUAL CONDUCTANCE MICRO-MHOS	VOLTAGE AMPLIFICATION FACTOR	OHMS LOAD FOR STATED POWER OUTPUT	POWER OUTPUT MILLI-WATTS
				LENGTH	DIAM.		FILAMENT (OR HEATER)				D C ON FIL.	A C ON FIL.								
							VOLTS	AMPERES	SUPPLY											
UX -200-A	DETECTOR	MEDIUM 4-PIN	FIG. 1	4 1/16"	1 3/16"	FILAMENT	5.0	0.25	D C	45	—	45	—	1.5	—	30000	666	20	—	—
UX -201-A	DETECTOR, * AMPLIFIER	MEDIUM 4-PIN	FIG. 1	4 1/16"	1 3/16"	FILAMENT	5.0	0.25	D C	135	—	135	—	2.5	—	11000	725	8.0	—	—
WD - 11 WX - 12	DETECTOR, * AMPLIFIER	WD 4-PIN MEDIUM 4-PIN	FIG. 12 FIG. 1	4 1/8"	1 3/8"	FILAMENT	1.1	0.25	D C	135	—	135	—	2.5	—	15500	425	6.6	—	—
UX -112-A	DETECTOR, * AMPLIFIER	MEDIUM 4-PIN	FIG. 1	4 1/16"	1 3/16"	FILAMENT	5.0	0.25	D C	180	—	180	—	5.2	—	5600	1500	8.5	—	—
UX -222	RADIO FREQ. AMPLIFIER	MEDIUM 4-PIN	FIG. 4	5 3/32"	1 3/16"	FILAMENT	3.3	0.132	D C	135	—	135	—	6.2	—	5300	1600	8.5	—	—
UY -224-A	RADIO FREQ. AMPLIFIER	MEDIUM 5-PIN	FIG. 9	5 3/32"	1 3/16"	HEATER	2.5	1.75	A C or D C	275	90	180	—	4.0	—	850000	350	300	—	—
UY -224-A	BIASED DETECTOR	MEDIUM 5-PIN	FIG. 9	5 3/32"	1 3/16"	HEATER	2.5	1.75	A C or D C	275	90	180	—	4.0	—	800000	1000	400	—	—
UX -226	AMPLIFIER	MEDIUM 4-PIN	FIG. 1	4 1/16"	1 3/16"	FILAMENT	1.5	1.05	A C or D C	180	—	180	—	2.9	—	8900	935	8.3	—	—
UY -227	AMPLIFIER	MEDIUM 5-PIN	FIG. 8	4 1/16"	1 3/16"	HEATER	2.5	1.75	A C or D C	275	—	180	—	2.7	—	11000	920	9.0	—	—
UY -227	BIASED * DETECTOR	MEDIUM 5-PIN	FIG. 8	4 1/16"	1 3/16"	HEATER	2.5	1.75	A C or D C	275	—	180	—	2.7	—	11000	850	9.3	—	—
RCA-230	DETECTOR, * AMPLIFIER	MEDIUM 4-PIN	FIG. 1	4 1/16"	1 3/16"	FILAMENT	2.0	0.06	D C	180	—	180	—	2.5	—	11000	1000	9.0	—	—
RCA-232	RADIO FREQ. AMPLIFIER	MEDIUM 4-PIN	FIG. 4	5 3/32"	1 3/16"	FILAMENT	2.0	0.06	D C	180	67.5	180	—	1.7	0.4 max.	950000	640	610	—	—
RCA-232	BIASED DETECTOR	MEDIUM 4-PIN	FIG. 4	5 3/32"	1 3/16"	FILAMENT	2.0	0.06	D C	180	67.5	180	—	1.7	0.4 max.	1200000	650	780	—	—
RCA-234	SUPER-CONTROL R-F AMPLIFIER	MEDIUM 4-PIN	FIG. 4	5 3/32"	1 3/16"	FILAMENT	2.0	0.06	D C	180	67.5	180	—	2.7	1.1	400000	560	264	—	—
RCA-235	SUPER-CONTROL R-F AMPLIFIER	MEDIUM 5-PIN	FIG. 9	5 3/32"	1 3/16"	HEATER	2.5	1.75	A C or D C	275	90	180	—	2.8	1.0	600000	600	360	—	—
RCA-236	RADIO FREQ. AMPLIFIER	SMALL 5-PIN	FIG. 9	4 1/32"	1 3/16"	HEATER	6.3	0.3	D C	180	90	135	—	3.0	1.7	300000	1050	370	—	—
RCA-236	BIASED DETECTOR	SMALL 5-PIN	FIG. 9	4 1/32"	1 3/16"	HEATER	6.3	0.3	D C	180	67.5	135	—	3.0	1.7	300000	1050	315	—	—
RCA-237	AMPLIFIER	SMALL 5-PIN	FIG. 8	4 1/8"	1 3/16"	HEATER	6.3	0.3	D C	180	—	180	—	2.6	—	11500	780	9.0	—	—
RCA-237	BIASED * DETECTOR	SMALL 5-PIN	FIG. 8	4 1/8"	1 3/16"	HEATER	6.3	0.3	D C	180	—	180	—	2.6	—	10000	900	9.0	—	—
RCA-239	SUPER-CONTROL R-F AMPLIFIER	SMALL 5-PIN	FIG. 9	4 1/32"	1 3/16"	HEATER	6.3	0.3	D C	180	90	180	—	4.4	1.3	375000	960	360	—	—
UX -240	VOLTAGE AMPLIFIER	MEDIUM 4-PIN	FIG. 1	4 1/16"	1 3/16"	FILAMENT	5.0	0.25	D C	180	—	180	—	4.4	1.2	540000	900	530	—	—
RCA- 56	AMPLIFIER	SMALL 5-PIN	FIG. 8	4 1/8"	1 3/16"	HEATER	2.5	1.0	A C or D C	250	—	250	—	4.5	1.2	750000	1000	750	—	—
RCA- 56	BIASED * DETECTOR	SMALL 5-PIN	FIG. 8	4 1/8"	1 3/16"	HEATER	2.5	1.0	A C or D C	250	—	250	—	4.5	1.2	750000	1000	750	—	—
RCA- 57	RADIO FREQ. AMPLIFIER	SMALL 6-PIN	FIG. 11	4 23/32"	1 9/16"	HEATER	2.5	1.0	A C or D C	250	100	250	—	2.0	1.0 max.	exceeds 1.5 meg.	1225	exceeds 1500	—	—

RCA- 57	BIASED DETECTOR	SMALL 6-PIN	FIG. 11	4 23/32"	1 9/16"	HEATER	2.5	1.0	A C or D C	250	100	275	—	2.0	—	—	—	—	—	—	—
RCA- 58	SUPER-CONTROL R-F AMPLIFIER	SMALL 6-PIN	FIG. 11	4 23/32"	1 9/16"	HEATER	2.5	1.0	A C or D C	250	100	250	—	2.0	—	800000	1600	1280	—	—	
UV -199 UX -199	DETECTOR, * AMPLIFIER	SMALL 4-PIN SMALL 4-PIN	FIG. 10 FIG. 1	3 1/8" 4 1/8"	1 1/8" 1 1/8"	FILAMENT	3.3	0.063	D C	90	—	90	—	2.5	—	15500	425	6.6	—	—	

* For Grid-leak Detection—plate volts 45, grid return to + filament or to cathode. † Applied through plate coupling resistor of 250000 ohms. ‡ Applied through plate coupling resistor of 250000 ohms or 500 henry choke shunted by 0.25 megohm resistor. § Applied through plate coupling resistor of 100000 ohms. ¶ Screen current not over 1/3 of plate current.

POWER AMPLIFIERS

RCA-210	POWER AMPLIFIER	MEDIUM 4-PIN	FIG. 1	5 5/8"	2 3/16"	FILAMENT	7.5	1.25	A C or D C	425	—	250	—	10.0	—	6000	1330	8.0	13000	400
UX -112-A	POWER AMPLIFIER	MEDIUM 4-PIN	FIG. 1	4 1/16"	1 3/16"	FILAMENT	5.0	0.25	D C	180	—	135	—	6.2	—	5300	1600	8.5	8700	115
UX -120	POWER AMPLIFIER	SMALL 4-PIN	FIG. 1	4 1/8"	1 3/16"	FILAMENT	3.3	0.132	D C	135	—	180	—	7.6	—	5000	1700	8.5	10800	260
RCA-231	POWER AMPLIFIER	SMALL 4-PIN	FIG. 1	4 1/8"	1 3/16"	FILAMENT	2.0	0.130	D C	180	—	180	—	6.0	—	8000	415	3.3	9600	45
RCA-233	POWER AMPLIFIER	MEDIUM 5-PIN	FIG. 6	4 1/16"	1 3/16"	FILAMENT	2.0	0.26	D C	135	135	135	—	13.5	—	6300	525	3.3	6500	110
RCA-238	POWER AMPLIFIER	SMALL 5-PIN	FIG. 9	4 1/32"	1 3/16"	HEATER	6.3	0.3	D C	135	135	135	—	13.5	—	4100	925	3.8	7000	185
UX -245	POWER AMPLIFIER	MEDIUM 4-PIN	FIG. 1	5 5/8"	2 3/16"	FILAMENT	2.5	1.5	A C or D C	275	—	250	—	22.0	—	3100	1050	3.8	5700	375
RCA- 46	POWER AMPLIFIER CLASS B	MEDIUM 5-PIN	FIG. 7	5 5/8"	2 3/16"	FILAMENT	2.5	1.75	A C or D C	450	—	250	—	31.0	6.0	60000	2500	150	7000	2500
RCA- 46	POWER AMPLIFIER CLASS B	MEDIUM 5-PIN	FIG. 7	5 5/8"	2 3/16"	FILAMENT	2.5	1.75	A C or D C	450	—	400	—	31.0	6.0	60000	2500	150	7000	2000
RCA-247	POWER AMPLIFIER	MEDIUM 5-PIN	FIG. 6	5 5/8"	2 3/16"	FILAMENT	2.5	1.75	A C or D C	250	250	250	—	15.0	16.5	250	31.0	6.0	60000	2500
UX -250	POWER AMPLIFIER	MEDIUM 4-PIN	FIG. 1	6 1/2"	2 1/16"	FILAMENT	7.5	1.25	A C or D C	450	—	350	—	45.0	—	1900	2000	3.8	4100	2400
UX -171-A	POWER AMPLIFIER	MEDIUM 4-PIN	FIG. 1	4 1/16"	1 3/16"	FILAMENT	5.0	0.25	A C or D C	180	—	135	—	12.0	—	2250	1330	3.0	3200	125

• Two grids tied together. ¶ Grid next to plate tied to plate.

RECTIFIERS

UX -280	FULL-WAVE RECTIFIER	MEDIUM 4-PIN	FIG. 2	5 5/8"	2 3/16"	FILAMENT	5.0	2.0	A C	A C Voltage per Plate (Volts RMS)..... 350 400 550 For d-c output voltage, refer to D-C Output Current (Maximum MA.)..... 125 110 135 curves in Manual. The 550 volt rating is permissible only with filter circuits having an input choke of at least 20 henries.									
UX -281	HALF-WAVE RECTIFIER	MEDIUM 4-PIN	FIG. 3	6 1/4"	2 1/16"	FILAMENT	7.5	1.25	A C	A-C Plate Voltage (Maximum Volts RMS)..... 700 For d-c output voltage delivered to filter of typical D-C Output Current (Maximum MA.)..... 85 rectifier circuit refer to curves in Manual.									
RCA- 82	FULL-WAVE MERCURY-VAPOR RECTIFIER	MEDIUM 4-PIN	FIG. 2	4 1/16"	1 3/16"	FILAMENT	2.5	3.0	A C	Maximum A-C Voltage per Plate..... 500 Volts, RMS Maximum D-C Output Current, Continuous..... 125 Milliamperes Maximum Peak Inverse Voltage..... 1400 Volts Maximum Peak Plate Current..... 400 Milliamperes Approximate Tube Voltage Drop..... 15 Volts									
RCA-866	HALF-WAVE MERCURY-VAPOR RECTIFIER	MEDIUM 4-PIN	—	6 5/8"	2 7/16"	FILAMENT	2.5	5.0	A C	Maximum Peak Inverse Voltage..... 7500 Volts Maximum Peak Plate Current..... 0.6 Ampere For additional information refer to Approximate Tube Voltage Drop..... 15 Volts Technical Bulletin.									

REGULATORS

UX -874	VOLTAGE REGULATOR	MEDIUM 4-PIN	—	5 5/8"	2 3/16"	Designed to keep output voltage of B-Eliminators constant when different values of "B" current are supplied.						Operating Voltage..... 90 Volts D C Starting Voltage..... 125 Volts D C Operating Current..... 10-50 Milliamperes			
UV -876	CURRENT REGULATOR (BALLAST TUBE)	MOGUL	—	8"	2 1/16"	Designed to insure constant input to power operated radio receivers despite fluctuations in line voltage.						Operating Current..... 1.7 Amperes Voltage Range..... 40-60 Volts			
UV -886	CURRENT REGULATOR (BALLAST TUBE)	MOGUL	—	8"	2 1/16"	Designed to insure constant input to power operated radio receivers despite fluctuations in line voltage.						Operating Current..... 2.05 Amperes Voltage Range..... 40-60 Volts			

For other RCA Radiotrons of special interest to the radio amateur, refer to inside of back cover.

